

4 Series

Audio
Management
Systems

Operators Manual Revision 1.00

**XTA Electronics Ltd.
The Design House,
Vale Business Park,
Worcester Road,
Stourport-on-Severn,
Worcs. DY13 9BZ.
England**

**Tel: 01299 879977 (Intl. +44 1299 879977)
Fax: 01299 879969 (Intl. +44 1299 879969)
Web: <http://www.xta.co.uk>**



© XTA Electronics Ltd 2006

Designed & written by Waring Hayes 05/2006
If you have any comments or suggestions about this manual, please
contact XTA at the address above, or email manuals@xta.co.uk

4 Series Quick Reference

Editing channels : press channel's **GAIN** key. First press accesses that channel's gain. To scroll through channel's parameters, use the **BACK** and **NEXT** keys. Second press accesses last viewed parameter. Third press will drop back to the default screen.

Accessing menus: press the **MENU** key. Use the **BACK** and **NEXT** keys to select the sub-menu required, and enter the sub-menu using the **ENTER** key. This applies to all levels of menu. **ENTER** always confirms selections.

The Menus and their Contents

GLOBAL MEMORY Sub-menu: Recall/Store/Erase input, graphic and crossover settings, or combinations of.

INPUT SECTION Sub-menu: Set up input ganging, and GEQ 'Q' setting.

CROSSOVER Sub-menu: Set up or adjust crossover design, including routing and auto limiter setting. Also set up output ganging.

INTERFACE Sub-menu: Comms interface setup (RS232 and RS485), G.P.I. interface configuration, and wireless interface.

SYSTEM Sub-menu: Used to view unit's status, and select various global options such as PEQ 'Q' or bandwidth units, delay units, and output metering point (pre/post mute).

SECURITY Sub-menu: Used for locking various operations of the unit, using a 4 digit code.

AES/EBU Sub-menu: Switch outputs from analogue to digital and monitor AES input status info. (AES inputs are switched via rear panel.)

Notes

The crossover (output) settings may be stored independently of the input settings and graphic EQ, using the **Global Memory** sub-menu.

The output meters show level, in dB from the limiter threshold, and the input meters show level from clipping the A-D converters, pre-gain and all EQ.

The high and low pass crossover filters are defined independently on each output channel.

To access the limiter attack and release parameters, select "AutoLimiter TimeCst: No" when designing a crossover.

To swap parametric filter units between bandwidth ('BandW') and 'Q', enter **System** Sub-menu, select 'Filter Q / Bandwidth', and select required readout units.

To swap delay time units, enter **System** Sub-menu, select 'Delay Time / Distance', and select required readout units.

Pressing an **EDIT** key flashes corresponding channels routed to / from that channel.

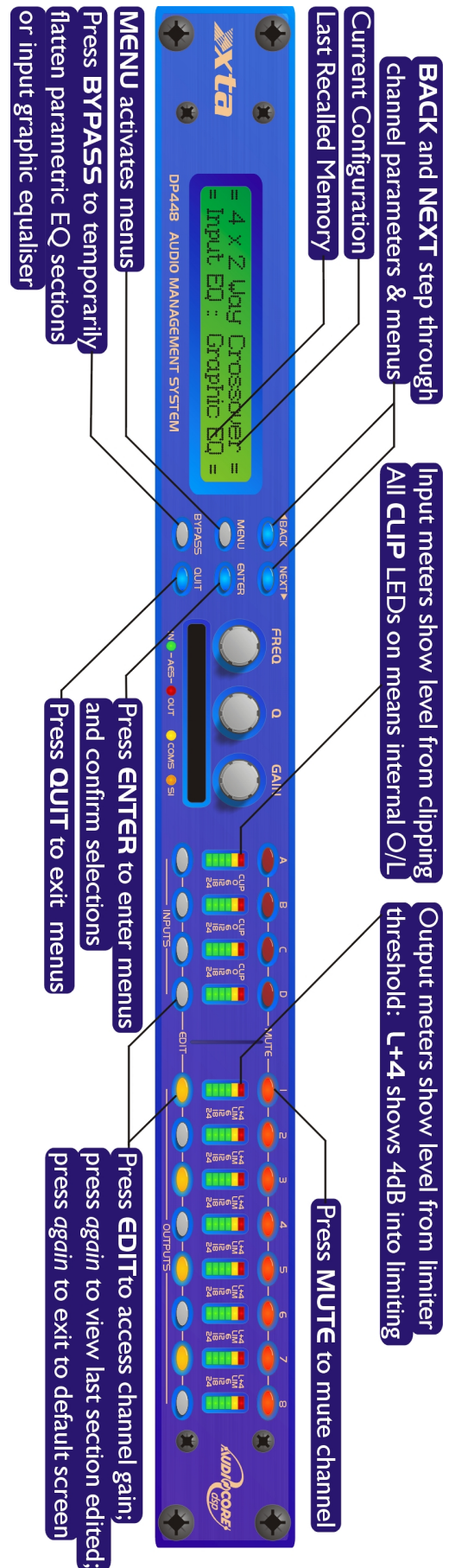

Contents

Important Safety Information	6
Thanks	7
Unpacking the unit	7
Introduction	8
Features	8
Front Panel Familiarisation	9
Rear Panel Connections	10
Operating the 4 Series	11
Note about operation with AudioCore software.	11
Start-up procedure	11
Preliminary Set-up	11
Input Channel Makeup	12
Output Channel Makeup	12
Preset Routing Configurations (DP448 shown)	12
Free Assign Routing	15
Input Gain	16
Base Delay	16
Input Graphic EQ	16
Input Parametric EQ	16
Output Gain	17
Output Polarity	17
Output Delay	17
Output High Pass Filter	18
Output Low Pass Filter	18
Output Parametric EQ	18
Output Limiter	19
Output “D-Max” (Clip) Limiter	19
Input Ganging and Output Ganging	20
Menu System Overview	21
Menus in Detail	23
Memory Structure	24
Remote Control Interface Operation	26
RS232 Interface	26
RS232 Connection (Single Unit)	26
Loading New Software via a PC	27
RS232 Connection (Multiple Units)	27
Shadow ID Numbers	28
RS485 Connection	29
AES Inputs and Outputs	31
AES Input	31
AES Output	31
AES Diagnostics and Status Information	32



Security and Locking	33
Entering the Password to Complete the Locking Operation	33
Unlocking the Unit	34
Forgotten the Password?	34
PCMCIA Card and Compact Flash Card Usage	35
Preset Library Updates via the card	35
Unit Software Updates via the card	35
Unit Cloning	36
Copying Unit Software and Preset Files	36
<i>Copying Data from Source Unit</i>	36
<i>Loading Data into Destination Unit</i>	36
<i>Cold Start Reboot Procedure</i>	36
Advanced Audio Features	37
Graphic Equaliser Behaviour	37
<i>The "GQ600" behaviour</i>	37
<i>The "Special" behaviour</i>	38
Program Limiter and "D-Max" Limiter	39
<i>Program Limiter</i>	39
<i>"D-Max" Clip Limiter</i>	40
Setting Accurate Limiter Thresholds	42
Crossover Filter Slopes	43
Time Alignment	43
Parametric Filter Types and Their Uses	44
<i>Standard Parametric EQ</i>	44
<i>Shelving EQ (High Shelf shown)</i>	45
<i>Creating a Flat-topped EQ Response</i>	45
<i>Notch Filter</i>	46
<i>All Pass Filter</i>	47
<i>Phase Filter</i>	47
<i>Low/High Pass Variable 'Q' Filter (Low Pass shown)</i>	48
<i>Elliptical filters</i>	49
Specifications	50
Warranty	51
Options and Accessories	51
Index	52
Appendix I – DP446 Default Crossover Configurations	54
Appendix II – DP444 Default Crossover Configurations	55
Appendix III – DP424 Default Crossover Configurations	58





An example of this equipment has been tested and found to comply with the following European and international Standards for Electromagnetic Compatibility and Electrical Safety:

Radiated Emissions (EU): EN55013-1 (1996)
 RF Immunity (EU): EN55103-2 (1996) RF Immunity, ESD, Burst Transient, Surge, Dips & Dwells
 Electrical Safety (EU): EN60065 (1993)

Important Safety Information

Do not remove Covers.
No user serviceable parts inside, refer servicing to qualified service personnel.
This equipment must be earthed.



CAUTION
RISK OF ELECTRIC SHOCK
DO NOT OPEN
DO NOT EXPOSE TO RAIN, MOISTURE,
DRIPPING OR SPLASHING



ATTENTION
RISQUE DE CHOC ELECTRIQUE
NE PAS ENLEVER
NE PAS EXPOSER A LA PLUIE NI A L'HUMITE



Objects containing liquids, such as vases, must not be placed on this equipment.

It should not be necessary to remove any protective earth or signal cable shield connections.

Do not defeat the purpose of the polarized or grounding-type plug. A polarized plug has two blades with one wider than the other. A grounding type plug has two blades and a third grounding prong. The wider blade and the third prong are provided for your safety. When the provided plug does not fit into your outlet, consult an electrician for replacement of the obsolete outlet.

Only use this equipment with an appropriate mains cord.

In the USA the cord should comply with the requirements contained in the Standard for Cord Sets and Power Supply Cords, UL 817, be marked VW-I, and have an ampacity rating not less than the marked rating of the apparatus.



Thanks

Thank you for choosing an XTA 4 Series for your application. Please spend a little time reading through this manual, so that you obtain the best possible performance from the unit.

All XTA products are carefully designed and engineered for cutting-edge performance and world-class reliability. If you would like further information about this or any other XTA product, please contact us.

We look forward to hearing from you in the near future.



Unpacking the unit

After unpacking the unit, please check it carefully for any damage. If any is found, immediately notify the carrier concerned - you, the consignee, must instigate any claim. Please retain all packaging in case of future re-shipment.

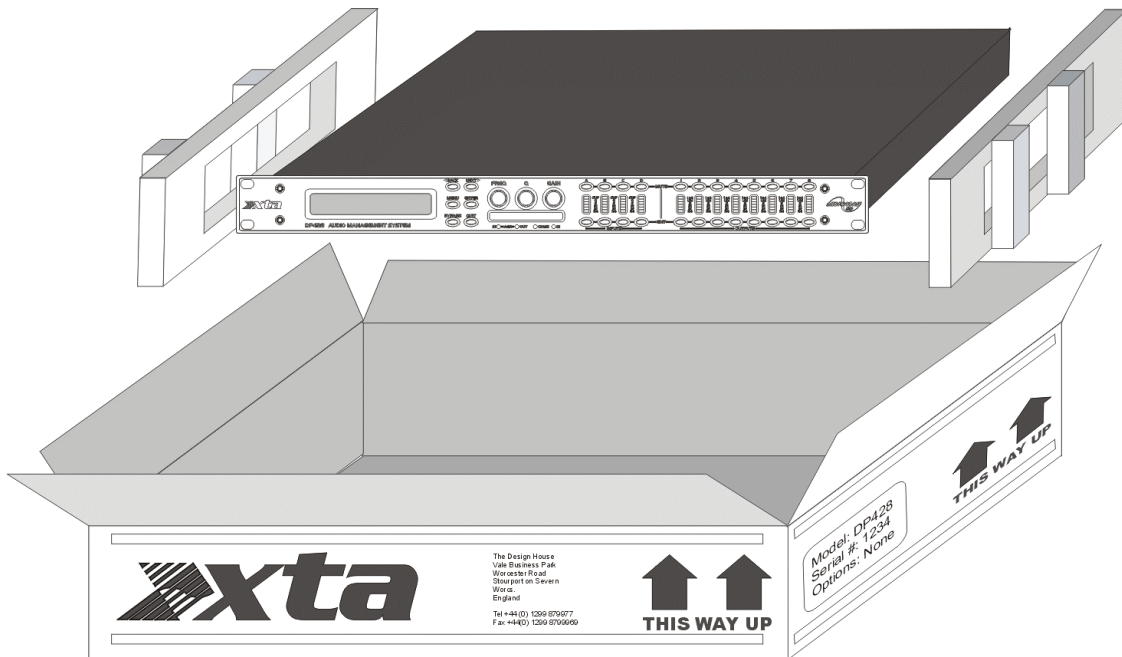

Please think of our environment and don't bin any materials, including this manual. When the product has reached the end of its useful life, please dispose of it responsibly through a recycling centre.



Introduction

The **4 Series** are powerful DSP based audio processors, ideally suited for install applications, where they combine the functions of a multitude of conventional products in a compact IU unit with extensive remote control capabilities. To achieve this, the units have up to four inputs and eight outputs which can be configured in a selection of basic crossover modes – 4 x 2 way; 2 x 3 way + 2 Aux; 2 x 4 way; and 1 x 8 way (as applicable to i/o configurations). They also offer a “free assign” mode, which allows completely flexible routing of any output from any combination of inputs.

Each input has a gain control, variable delay, a 28 band graphic equaliser and a further eight bands of fully parametric equalisation. The parametric filter bands have a large selection of different filter types available, including shelving, notch, band-pass, phase and elliptical behaviours.

Each output has a gain control, variable delay, high and low pass crossover filters, nine bands of fully parametric equalisation, polarity switching and, additionally, a fully featured limiter, and a final clip limiter. The crossover filters offer slopes of up to 48dB/Octave., with a variety of responses available.

Remote control¹ is catered for in the form of RS232 and RS485 ports, and multiple user memories are provided for the storage and recall of settings. A GPI interface may also be fitted to allow remote memory recalls using simple switch closure apparatus.

Security lock-out is available for all controls.

The **4 Series** are also equipped with AES/EBU digital inputs and outputs, and include a sample rate converter, capable of accepting anything from 32kHz up to 192kHz.

They may be controlled externally by XTA's proprietary  Windows™ software, along with existing and future 'AudioCore' products.

Features

Superb audio quality – carefully optimised double precision signal processing coupled with 24 bit conversion ensure a dynamic range in excess of 117dB. The high sampling rate of 96kHz means minimal filtering providing exceptional sonic purity with a bandwidth in excess of 32kHz.

A flexible input/output multi-mode format caters for any configuration, regardless of scale.

Both routing of inputs to outputs, and ganging (for editing) are completely flexible.

A completely new SHARC™ based DSP platform supplies phenomenal computational power, allowing the unit to provide not only multiple bands of standard parametric equalisation on every input and output, but an additional full spectrum graphic equaliser on each of the four inputs. This additional power also permits both program limiters and no overshoot clip limiters on each output.

Delay of up to 650mS may be independently set for each output, with an exceptionally fine minimum increment of 300nS, which corresponds to a distance change of 0.1mm!

The comprehensive standard specification also includes up to 255 memories, and remote control via RS232 or RS485 ports, with security lockout.

¹ Note that only the RS232 and RS485 interfaces offer full remote control of this product – the GPI interface may only be used for memory recall (program change) purposes.



Front Panel Familiarisation

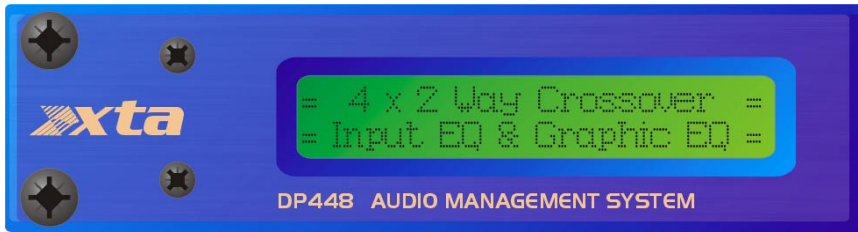

LCD Screen: Shows, by default, the name of the last recalled memory on the bottom line of the screen, and the current routing on the top line. Also used to show all parameters as they are edited, and all menu selections.

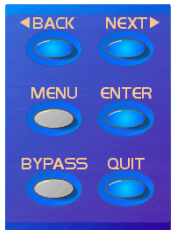

Control Keys: Selection and adjustment of parameters.

NEXT key moves forward through list of parameters.

BACK key moves backwards through list of parameters.

MENU key activates the main menu – a second press selects the last menu edited – a third press selects the last menu item. In this way, three presses on **MENU** from the default screen will jump back to the last parameter adjusted. Selection of different menus is accomplished using the **BACK** and **NEXT** keys, or with the **FREQ** encoder.

ENTER key enters the chosen menu, confirms selections, and changes filter types when editing parametric sections.

BYPASS will flatten the currently selected parametric sections, or input graphic equalisers. Note that, for safety reasons, it is not possible to bypass the high and low pass filter sections.

QUIT exits menus back to the default screen.



Rotary Encoders: Three velocity sensitive encoders adjust the relevant parameters as displayed on the screen.

Memory Card Slot: Will accept type I or type II PCMCIA SRAM cards and, using an adapter, Compact Flash cards. This allows the unit to be cloned, memory sets saved, presets loaded, and firmware updates installed.

Status LEDs: The four status LEDs show, from left to right, AES inputs selected (flashing if not locked); AES outputs selected; Comms activity (only illuminates on messages addressed to this particular unit); and a general-purpose spare indicator.

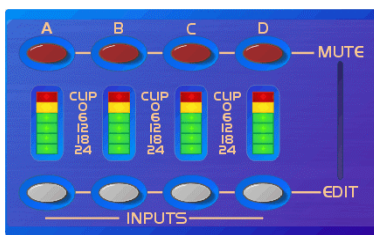

Input Sections: Control and monitor input signal paths.

Red **MUTE** buttons illuminate when pressed and mute audio for that channel.

EDIT buttons illuminate yellow when pressed, and access gain on first press, then last viewed parameter on second press, then exit on third press.

Input meters show dB from clipping point of the analogue to digital converters.

Yellow (**OdB**) LED illuminates 3dB from clipping. Red **CLIP** LED may illuminate independently from the rest of the meter to show digital overflow. All four **CLIP** LEDs illuminating indicates internal clipping after the ADC.

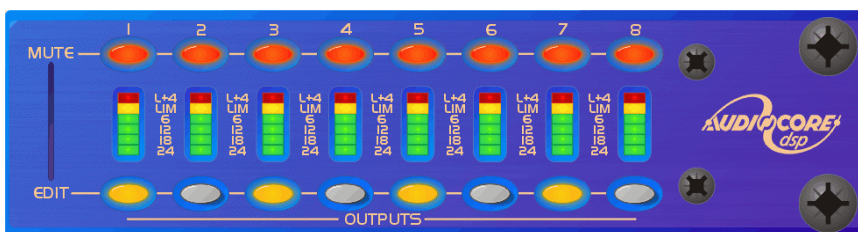

Output Sections: Control and monitor output signal paths.

Red **MUTE** buttons illuminate when pressed and mute audio for that channel.

EDIT buttons illuminate yellow when pressed, and access gain on first press, then last viewed parameter on second

press, then exit on third press. Output meters show dB from limiting. The yellow LED illuminates at the onset of limiting. The red LED illuminates at 4dB into limiting (i.e. 4dB of gain reduction).



Rear Panel Connections

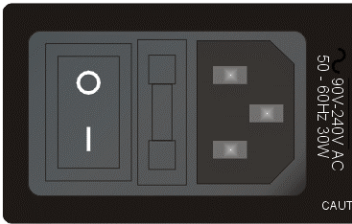

Power Switch: turns the unit's mains supply off and on.
Mains Fuse: located in a finger-proof holder adjacent to the mains inlet. A spare fuse is also located in this holder.
Mains Inlet: connected via a standard IEC socket.



RS232: RS232 standard via a 9 pin D-type connector, for connection to a PC. Data is converted to RS485 standard and relayed to slave units via the RS485 sockets.
RS485 In-Out: XLR sockets. Used for transmission of remote control data over long distance or multiple unit applications. See page 28 for more information.

For more details on interfaces see our Interface Guide, available from the website.



Audio Outputs: 3 pin XLR sockets are provided for each channel. All are fully balanced, pin 2 hot, 3 cold, 1 screen. Note the legending on the panel to designate which outputs are used for AES streams when the digital outputs are enabled. Please see page 31 for more information.



AES Input Switch: Recessed switch to select AES digital inputs. Red LED will illuminate in the hole when AES inputs are selected, along with the corresponding front panel indicator.

Audio Inputs: 3 pin XLR sockets are provided for each channel. All are fully balanced, pin 2 hot, 3 cold, 1 screen.

Note the legending on the panel to designate which inputs are used for AES when the digital inputs are enabled. Please see page 31 for more information.



Always replace the fuse with the correct type and rating as shown on the rear panel legend.



Operating the 4 Series

Note about operation with AudioCore software.

The following operating information covers setup and control of the **4 Series** via the front panel controls only. Please consult the manual supplied with this software for information regarding full computer control.

Start-up procedure

Switching on the unit will display a brief message detailing the unit type and software version running

```
== AudioCore DP4XX ==  
==Software V 1.00 ==
```

and all LEDs will briefly illuminate. The unit will then begin its countdown to the wake-up procedure², during which time the audio will fade up to the level last set. Metering will begin to operate when the fade-up starts.

Preliminary Set-up

The procedure below should be followed when first installing a **4 Series** unit.

- ✓ Design your crossover! To do this, press **MENU**, and use the **BACK** or **NEXT** key to select 'Crossover sub-menu' and then press **ENTER**. Use the **BACK** or **NEXT** key to select 'Design a crossover' and then press **ENTER**. Finally, use the **BACK** or **NEXT** key to select the desired routing³ and follow the set-up wizard to finalise your design.
- ✓ Note that when in a menu, **ENTER** is always used to confirm selections. The current selection is marked with an asterisk '*'.
- ✓ Use the **EDIT** keys on each output channel with the **BACK** and **NEXT** keys to select the high pass filters, low pass filters, parametrics etc. Note that when designing a new crossover, the high and low pass filters will be set to default values.
- ✓ Use the **EDIT** keys on each input channel with the **BACK** and **NEXT** keys to select the gain, delay and parametrics available on each input.



Note that if no action is taken in menu mode, the unit will return to normal 'default' mode after about twenty (20) seconds. Repeat the above directions to return to menu mode.

² The wake-up time countdown may be adjusted in the **SYSTEM** menu – see page 23 for details.

³ For details about adjusting the routing if one of the standard configurations does not suit, see page 15.



Routing Options and Processing Blocks

Due to the completely new DSP platform, the routing possibilities within the **4 Series** have been made completely flexible, with a matrix available allowing any combination of inputs to be routed to any output. The additional DSP power has permitted the inclusion of more processing blocks, even considering the extra inputs and outputs, and the doubling of sample rate.

To reduce set-up time and aid usability, several standard configurations are available as described in a later section.

This section will outline the processing blocks available in relation to the signal path, and explain the various options for routing, including the “Free Assign” mode, which opens up completely flexible channel routing.

Input Channel Makeup

The diagram below shows the processing available on each of the four input channels, before routing to the matrix.

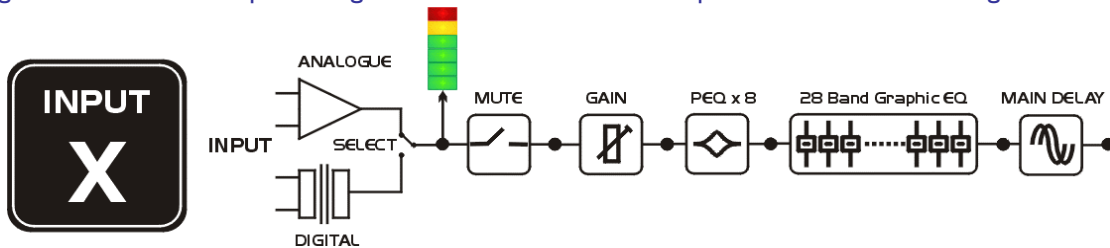

Output Channel Makeup

The diagram below shows the processing available on each of the eight output channels, after routing from the matrix.

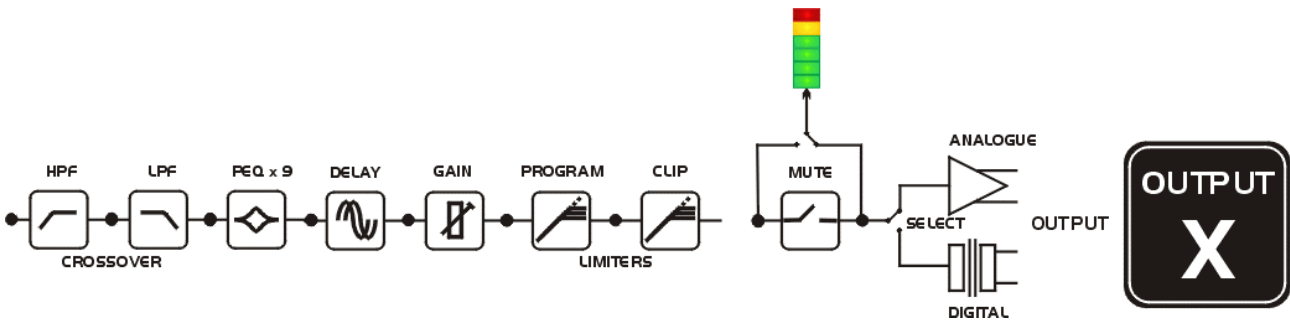

Preset Routing Configurations (DP448 shown)

In addition to the ability to assign any combination of inputs to any output, a number of preset configurations are provided, for use when designing a crossover from scratch. These have the advantage of suggested settings for the high and low pass filters to useful basic starting points, to filter the different outputs as appropriate for the chosen configuration. These may, of course, be freely modified afterwards should they not suit the requirements exactly.

The diagrams on the following pages show the connections made between inputs and outputs, and the suggested values chosen for the high and low pass filters.



4 x 2 way crossover: As shown, each input feeds a pair of outputs, odd numbers being the low frequency split, and even numbers being the high part of the spectrum. Default suggested crossover frequencies are shown by each output.

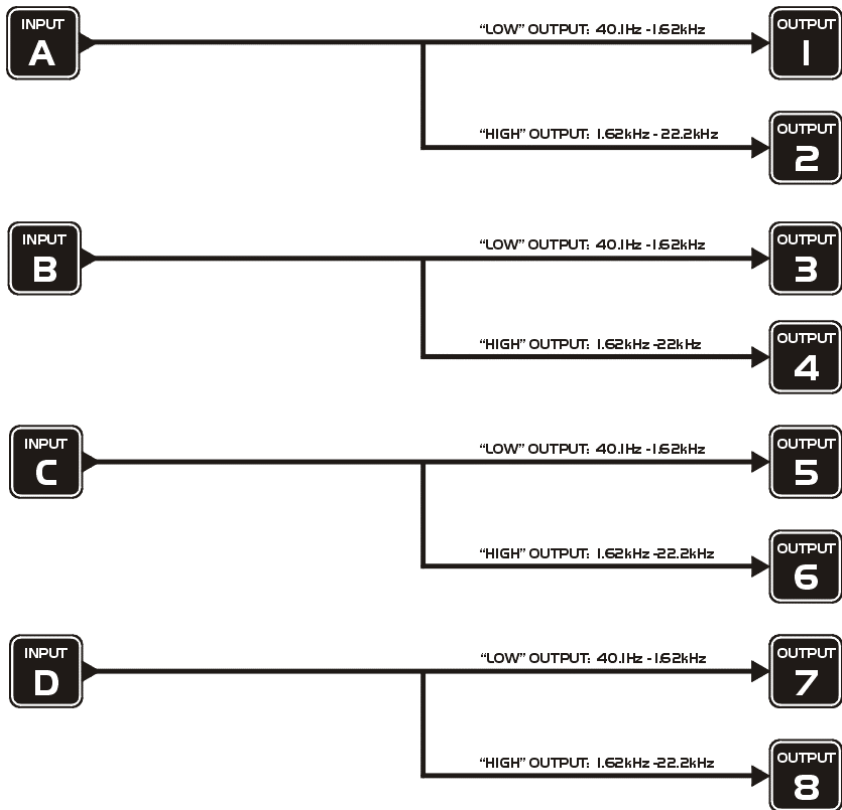

2 x 3 way crossover: Inputs A and B feed three outputs each, with output 7 being fed from input C, and output 8 from input D. Note the 'Aux' outputs are set to full range. Default suggested crossover frequencies are shown by each output.

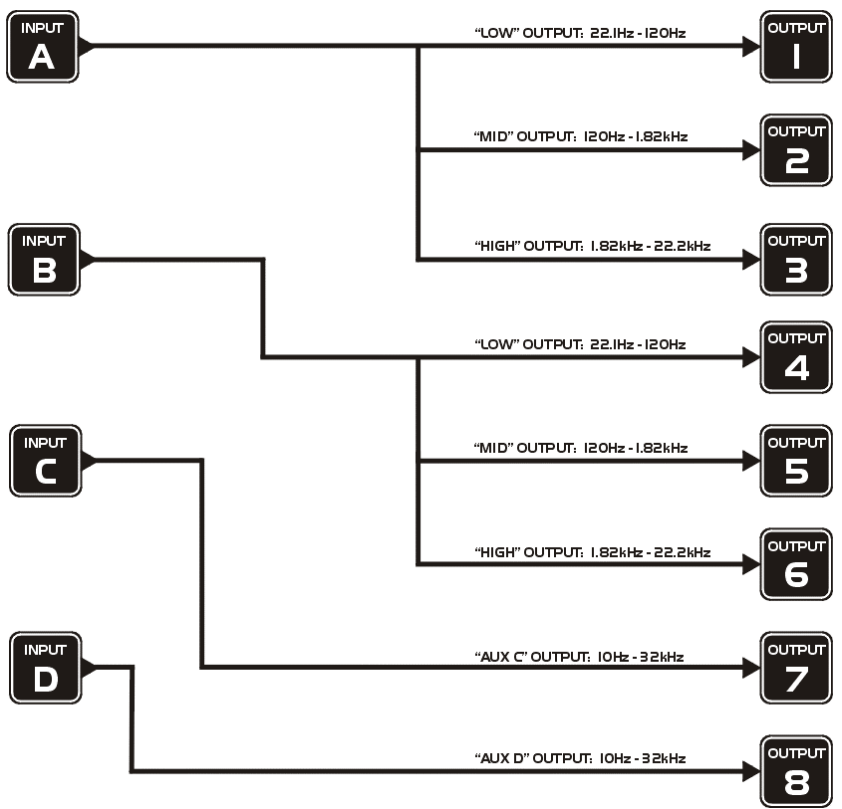

2 x 4 way crossover: Inputs A and B feed four outputs each, with inputs C & D being unused. Default suggested crossover frequencies are shown by each output.

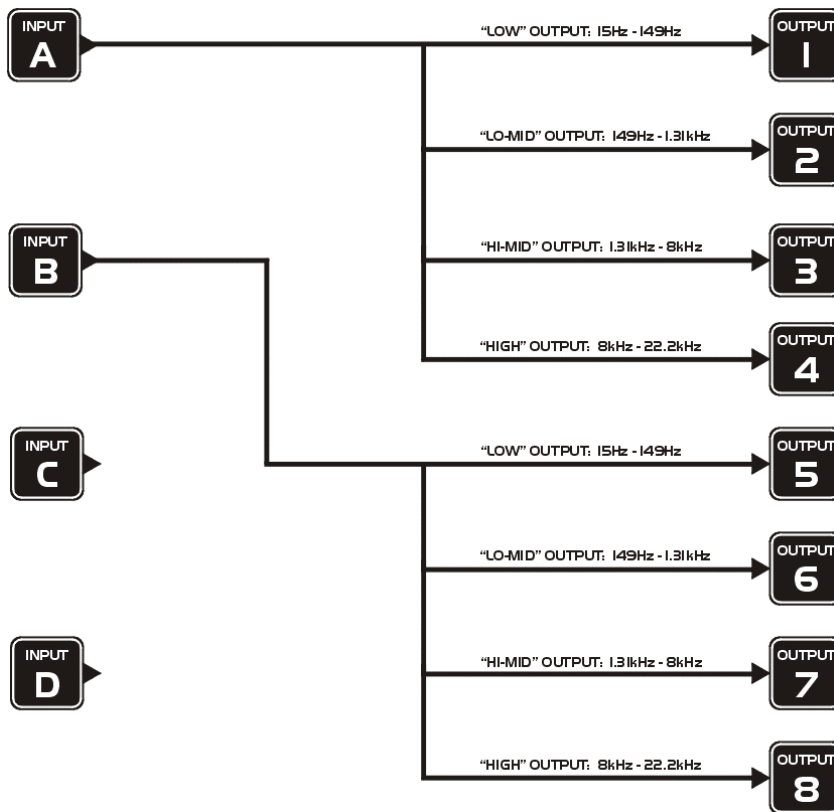

1 x 8 way crossover: Inputs A is fed to all eight outputs, with initial settings being all full bandwidth. The crossover points can be adjusted as desired.

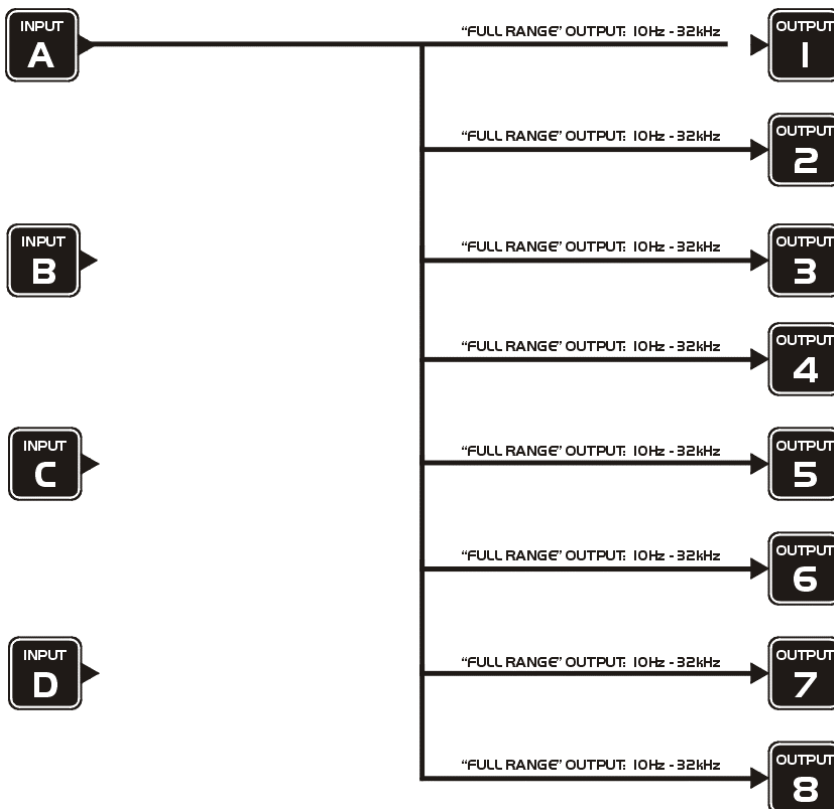

Free Assign Routing

If none of the preset configurations are appropriate to the required system setup, it is possible to manually select the routing of the crossover. This is achieved through the **Crossover Menu** -> **Design A Crossover**.

Pressing **ENTER** will start the crossover design wizard, with the first option being to choose the routing.

The display will show

```
Design A Crossover ->
Routing = 2 X 4 WAY *
```

or whatever the current configuration is set to. Press **BACK** until the display shows

```
Design A Crossover ->
Routing = Free Assign
```

And then press **ENTER**. The **EDIT** key will illuminate for output 1, as will any relevant input **EDIT** keys, showing which inputs are feeding output 1. The display will also detail the current combination of inputs feeding this output. To change the routing for any output, press its **EDIT** key, and then choose the required input channel combination by just pressing the input **EDIT** keys as appropriate. The input combinations can also be stepped through in turn by pressing **NEXT**, or **BACK**.

To complete the procedure, press **ENTER**. The wizard will continue, and if the routing has been changed, all outputs will be muted on exit.

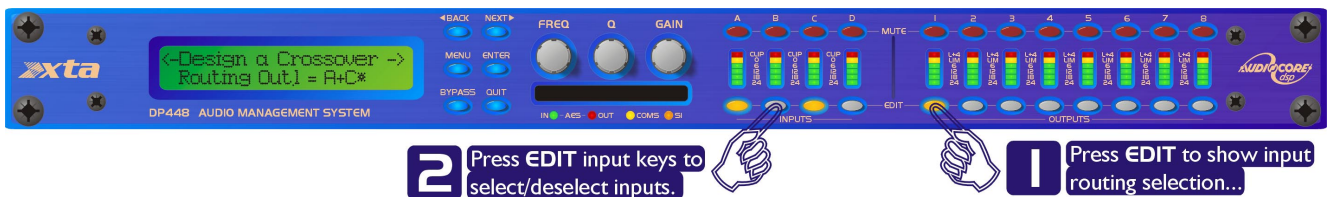

Editing Audio Parameters – Input Channels

Input Gain

The range of the control over the input gain is -40dB to +6dB in 0.1dB steps.

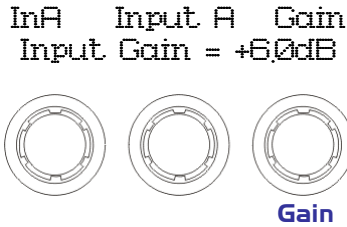

Base Delay

The maximum available delay between any input and output is 650.00mS. For example, if the input delay on channel A is set to 500mS, the maximum available output delay for any output fed from input A will be 150mS. The readout units can be changed between time in milliseconds, distance in feet or distance in metres. Please see page 23 for more details.

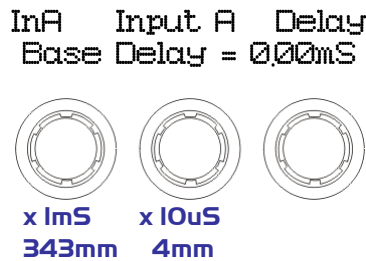

Input Graphic EQ

The graphic equaliser has 28 third octave bands from 31Hz to 16kHz, and a gain range of ± 12 dB. The **Q6** on the second line of the screen denotes the 'Q' behaviour of the graphic – this setting behaves like a GQ600 with variable 'Q' that is 'gentler' at low cut/boost values and sharpens at high cut/boost values. The alternate setting, **Sp**, is a constant 'Q' behaviour where no change in bandwidth occurs with differing cut/boost. Pressing **BYPASS** will bypass the entire Graphic EQ on this channel. For details of how to select the behaviour, please see page 23.

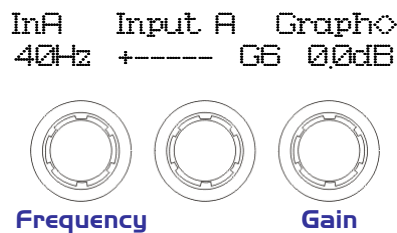

Input Parametric EQ

There are eight bands of parameter equalisation available on every input. The behaviour of each individual band can be changed to a variety of different filter shapes, including high and low shelves, notch, and bandpass. Changing the filter type is achieved by pressing **ENTER** during editing any particular band. For more details about the various types of filter available, please see page 42.

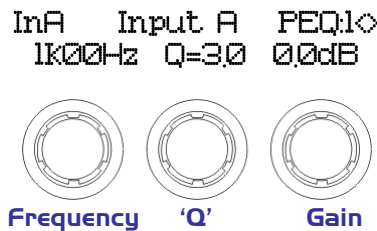

Editing Audio Parameters – Output Channels

Output Gain

The range of the control over the input gain is -40dB to +15dB in 0.1dB steps.

OP1 Output 1 Gain
Output Gain = +6.0dB

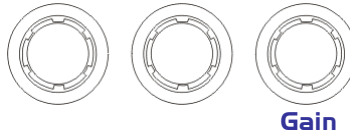

Output Polarity

The polarity (or phase) of each output may be switched individually as below.

OP1 Output 1 Polar.
Polarity = [+]

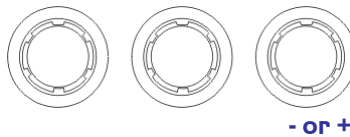

Output Delay

The maximum available delay between any input and output is 650.00mS. For example, if the input delay on channel A is set to 500mS, the maximum available output delay for any output fed from input A will be 150mS. The readout units can be changed between time in milliseconds, distance in feet or distance in metres. Please see page 23 for more details.

OP1 Output 1 Delay
Delay = 0.0000mS

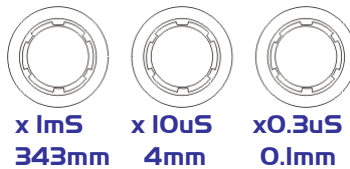

Output High Pass Filter

The high pass crossover filter on each output has a frequency range of < 10Hz up to 32kHz in 1/36th Octave steps. If you try to set the high pass filter to a higher frequency than the low pass (which would be pointless and result in no output), the message **High/Low Freq. Overlap!** will be displayed. Note that to access the 48dB/Octave filters, parametric bands 6 & 7 need to be bypassed, or set to 0dB. If they are not, the message **Bypass PEQ's 6 & 7 To Access 48dB Slopes** will be displayed.

```
OP1 Output 1 HPF /
<10Hz Linkw-Riley 48dB
```

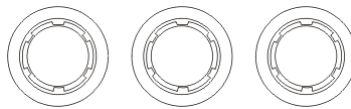

Frequency Slope

Output Low Pass Filter

The low pass crossover filter on each output has a frequency range of 35.1Hz up to > 32kHz in 1/36th Octave steps. If you try to set the low pass filter to a lower frequency than the high pass (which would be pointless and result in no output), the message **High/Low Freq. Overlap!** will be displayed. Note that to access the 48dB/Octave filters, parametric bands 8 & 9 need to be bypassed, or set to 0dB. If they are not, the message **Bypass PEQ's 8 & 9 To Access 48dB Slopes** will be displayed.

```
OP1 Output 1 LPF \
>32kHz Linkw-Riley 48dB
```

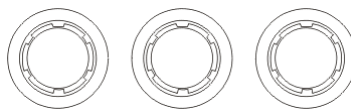

Frequency Slope

Output Parametric EQ

There are nine bands of parametric equalisation available on every output⁴. The behaviour of each individual band can be changed to a variety of different filter shapes, including high and low shelves, notch, and bandpass. Changing the filter type is achieved by pressing **BYPASS** to bypass the filter and then pressing **ENTER** during editing any particular band. For more details about the various types of filter available, please see page 42.

```
OP1 Output 1 PEQ:1
1k00Hz Q=3.0 0.0dB
```

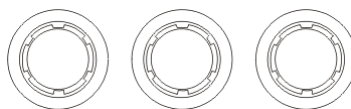

Frequency 'Q' Gain

⁴ Note that 2 bands each will be lost when using 48dB slope crossover filters, resulting in a maximum of 5 bands of EQ when both high and low pass are set to 48dB/Octave.



Output Limiter

The limiter on each output has adjustable attack and threshold, with a release time that is selectable to be a multiplier of the attack time. For example, as shown below, the attack time is 2mS and release is "x16" so 32mS. The attack and release times can be automatically linked to the high pass filter frequency, so that they are set to correct values for the output's frequency range. If this feature is enabled, the display will show **Automatic T/C** in place of the attack and release times. Selection of automatic time constants is through the **Design a Crossover** wizard, in the **Crossover Sub-Menu**.

OP1 Output 1 Limiter
Atk=20mS Rel=x16 +22dB



Output "D-Max" (Clip) Limiter

The clip limiter on each output is designed to sit at a threshold just above the standard limiter and has a look ahead attack so that its threshold can never be exceeded. The release time can be automatically linked to the high pass filter frequency, so that it is set to a value appropriate for the output's frequency range. If this feature is enabled, the display will show **Rel. = Auto** in place of the release time. Selection of automatic time constants is through the **Design a Crossover** wizard, in the **Crossover Sub-Menu**.

More information about the limiters and their use is given in the section on page 39.

OP1 Output 1 ClipLim
Rel=Medium 2dB Above

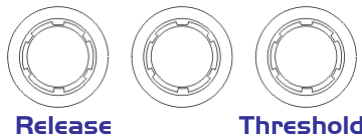

Input Ganging and Output Ganging

The method of linking inputs or outputs together during editing is achieved in the same way, so only crossover (output) ganging will be explained here. Having selected **Crossover Ganging** from the menu under the **Crossover Sub-Menu**, the current ganging set-up will be displayed. This will either be a preset selection as would be useful in a standard crossover configuration – for example

←Crossover Ganging
Ganging=1+3+5+7 2+4+6+8

...would be a logical ganging arrangement if the crossover was set up as a 4 x 2 way – linking the control and adjustment of all “Low” outputs together, and that of all “High” outputs together.

However, if the crossover has not been set up with a preset routing configuration, then it may be required to set up the ganging to compliment this configuration. This is achieved using the **Free Assign** mode. This is selected from the preset ganging choices⁵, which are:

Ganging=None	[all outputs independent]
Ganging=Free Assign	[choose ganging]
Ganging=1+2+3+4+5+6+7+8	[1 x 8 way]
Ganging=1+5 2+6 3+7 4+8	[4 x 2 way]
Ganging=1+3+5+7 2+4+6+8	[2 x 4 way]

Selecting **Free Assign** and then pressing **ENTER** will begin the process of ganging outputs together using the following simple rules:

- ✓ All outputs are ganged to the lowest number – so to gang 3 & 5, 5 must be selected and then ganged to 3.
- ✓ Outputs cannot share more than one ganging set – so for example output 3 cannot be ganged to 2 and 4 unless they are ganged together as well. (Effectively 3 and 4 are ganged to 2 in this case)

With these rules in mind, selecting and setting up gangs is quite straightforward.

Press a **MUTE** key to choose the output to gang – its LED will begin to flash, and an **EDIT** key will illuminate to show which output it is currently ganged with. To change this selection, just press another **EDIT** key, remembering that gangs work from the highest to lowest number. So, to gang outputs 1 and 5, press **MUTE 5** then **EDIT 1** – the display will show

←Crossover Ganging
Gang Output 5 with 1

Ganging is cleared by selecting **Ganging=None** from the initial choices given above. The **Input Ganging** procedure is identical to the crossover ganging, selectable under the **Input Sub-Menu**.

⁵ Ganging choices will be dependent on the **4 Series** unit in question and how many outputs it has.



Menu System Overview

Below is an overview of the menu system – a lot of functions have been assigned menu shortcuts – these are accessible directly from the default screen by pressing MENU followed by the appropriate **MUTE** or **EDIT** button as shown. This table only shows the top level of each menu item – some of these will start wizards or access additional functions, and these will be explained in later sections. **Note that currently the menu shortcuts only apply to the DP448.**

xxta HINT To jump back to the last menu item accessed directly from the default screen, press **MENU** three (3) times – first press is into menus, second is a jump to the sub-menu, third is to the item...

















































MAIN MENU						
GLOBAL MEMORY	INPUT SECTION	CROSSOVER	INTERFACE	SYSTEM	SECURITY	AES/EBU
Recall a Memory 	Input Ganging 	Design a Crossover 	External Interface 	System Status 	Unit Locking 	Output Selection
Store a Memory 	Input Reset 	Crossover Ganging 	Wiser 2400 Setup	LCD Contrast		AES Status Info.
Erase a Memory	Change Graph. Q/BW 		GPI Interface	LED Brightness		
				Temperature Alarm		
				Program Update		
				Wake-up Time		
				Output Meters		
				Filter Q/Bandwidth 		
				Delay Time/Dist'nce 		
				Unit Cloning		
				Preset Update		
				Clip LED Hold Time		
				Set Date & Time		

xxta INFO Note that if no action is taken in menu mode, the unit will return to normal 'default' mode after about twenty (20) seconds.. Repeat the above directions to return to menu mode.















Menu System Shortcuts

A lot of functions have been assigned menu shortcuts – these are accessible directly from the default screen by pressing **MENU** followed by the appropriate **MUTE** or **EDIT** button as shown. The entire list of features accessible in this way is given below. *Note that currently the menu shortcuts only apply to the DP448.*

- | | | |
|---|---|------------------------------------|
|  |  | Store Graphic Memory |
|  |  | Store Input Memory |
|  |  | Store Crossover Memory |
|  |  | Store Global Memory |
|  |  | Recall Graphic Memory |
|  |  | Recall Input Memory |
|  |  | Recall Crossover Memory |
|  |  | Recall Global Memory |
|  |  | System Status |
|  |  | External Interface Set-up |
|  |  | Change Graphic Q/Bandwidth |
|  |  | Filter Q/Bandwidth Display Readout |
|  |  | Delay Units Time/Distance Readout |
|  |  | AES Input Status |
|  |  | ----- |
|  |  | ----- |
|  |  | Design a Crossover |
|  |  | Input Ganging |
|  |  | Crossover (Output) Ganging |
|  |  | Input Reset |
|  |  | Unit Locking |
|  |  | AES Output Mode |
|  |  | ----- |
|  |  | ----- |



Menus in Detail

GLOBAL MEM	
Recall a Memory 	Recall Graphic, Input and Crossover Memories or combinations of.
Store a Memory 	Store Graphic, Input and Crossover Memories or combinations of.
Erase a Memory	Erase Graphic, Input and Crossover Memories or combinations of.
INPUT SECTION	
Input Ganging 	Gang (link) inputs together so their parameters track.
Input Reset	Start wizard to reset sections of input parameters, including graphics.
Change Graphic Q/BW	Select between 'GQ600' and other graphic behaviours.
CROSSOVER	
Design a Crossover 	Set up a new crossover from scratch. This selection starts a wizard to guide through the process. Also select this to alter the set-up of the current crossover.
Crossover Ganging 	Gang (link) outputs together so their parameters track.
INTERFACE	
External Interface 	Starts a wizard to configure the baud rate, ID and port selection of the remote interface.
Wiser 2400 Setup	Configures wireless interface (if connected).
GPI Interface	Configure the GPI inputs used for closed contact memory recall (hardware option).
SYSTEM	
System Status 	Displays a series of information screens including software version, temperature, hardware and firmware versions, date and time. Press NEXT to jump through info.
LCD Contrast	Adjust the viewing angle of the screen.
LED Brightness	Adjust the brightness of all the meters and button LEDs.
Temperature Alarm	Set the threshold for the unit to flash a warning temperature message on the screen.
Program Update	Select this option to install new operating software – see page 35 for more information.
Wake-up Time	Adjust the time before the audio fades in on start-up – can also be set to keep mutes on when powered up.
Output Meters Opt'n	Select the monitoring point for the meters – either pre or post mute (so meters can be set to work even when outputs muted)
Filter Q/Bandwidth 	Select the readout units for the 'Q' setting of parametric filters – 'Q' is 1/Bandwidth (in octaves) – small 'Q' values mean wide response variations.
Delay Time/Dist'nce 	Select the readout units for all delay values – either time, or distance in feet or metres.
Unit Cloning	Copy a unit's complete setup, including memories and all menu options using a PCMCIA card. See page 33 for more information on card types.
Preset Update	Load a new preset file from a PCMCIA card
Clip LED Hold Time	Select the time that the input CLIP LEDs stay illuminated for after an overload has passed.
Set Date & Time	Adjust the real time clock settings.
SECURITY	
Unit Locking 	Protect the unit against unauthorised access with a password - please see page 33 for more details.
AES/EBU	
Output Selection 	Switch the outputs of the unit to digital. (Inputs are selected via rear panel switch)
AES Status Info. 	Information screen showing details of the incoming AES streams (sample rate/lock).



Memory Structure

As with the DP226 and DP224, the **4 Series** have their memories split into sections, allowing independent recall of crossover settings (i.e. all parameters associated with outputs), and input settings. Additionally, the graphic equaliser settings are stored in independent locations.

There are, therefore, three types of memory available – **INPUT**, **CROSSOVER** and **GRAPHIC**. These, and all combinations of memory types, appear in the **GLOBAL MEMORY Sub Menu**, and its operation warrants a little more explanation.

Selecting to **Store** or **Recall** using the **Global Memory** option offers the possibility of storing various combinations of the available memory types, and these are selected using the **BACK** and **NEXT** keys.

To explain how this all works, please consider the following example.

There are 10 memories stored in the unit with various combinations of input, graphic and crossover memories.

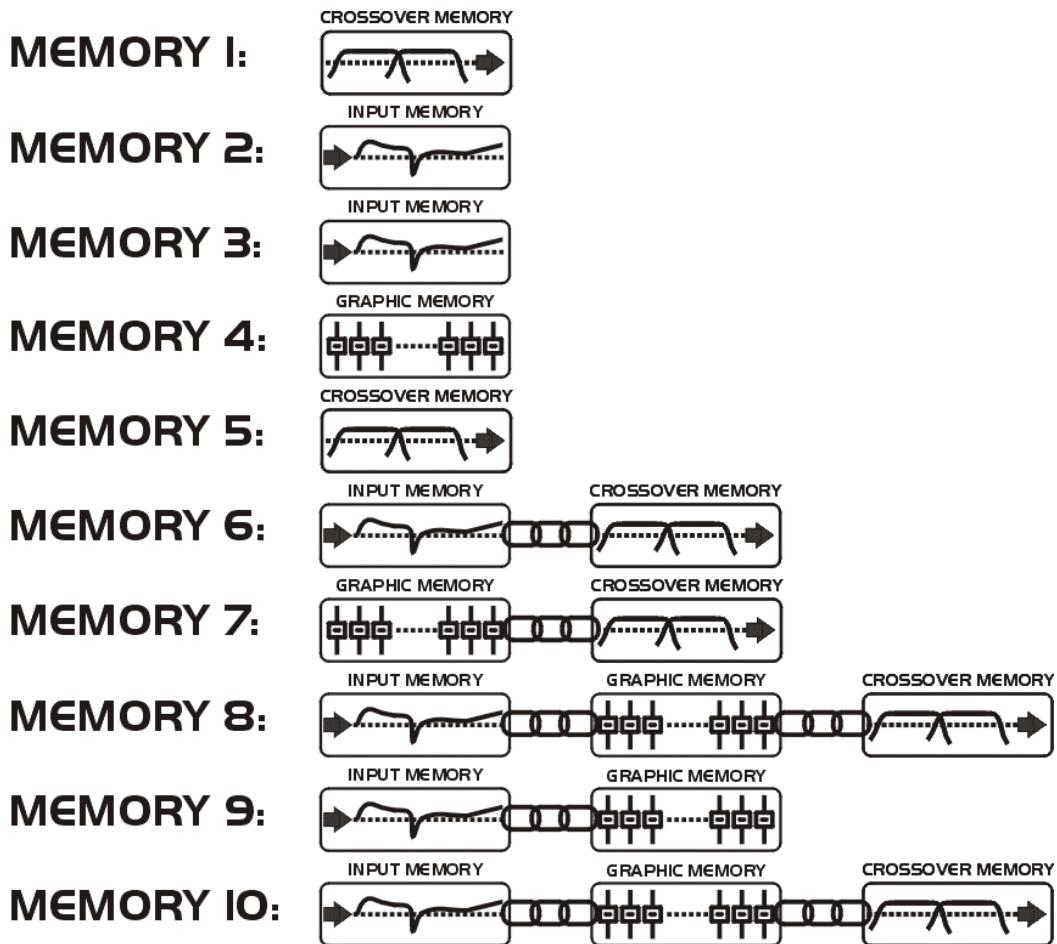

As can be seen, different memory locations contain different combinations of the three memory types available. If it is required to recall a location that contains Input, Graphic and Crossover settings, this will limit the selection as shown overleaf...



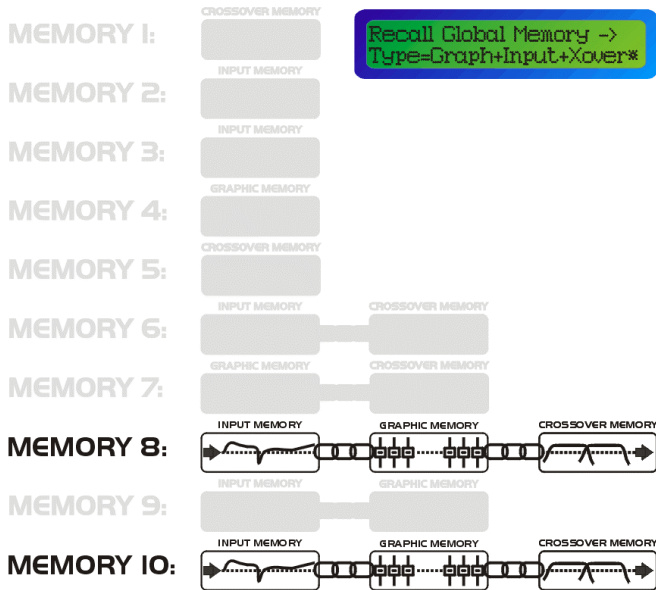

Recall Global Memory ->
Type=Graph+Input+Xover*

As only memory 8 and memory 10 have all 3 types stored, these will be the only numbers available during a recall.

However, consider the example where the type of recall is set to Input & Crossover. In this instance, not only will the memory locations that have just Input and Crossover types stored be available, but the locations 8 & 10 will also be shown in the list.

There will be three memories to choose from in this case, as location 6 is an Input & Crossover memory, whilst 8 and 10 will appear as they contain Input and Crossover information as well.

Recalling 8 or 10 will leave the current Graphic settings untouched.

Selection of Crossover memories only will additionally include locations 1 and 6 in the list of memories available for recall, as shown below.

In this way it is possible to recall part of a memory, as long as it contains the memory type required.

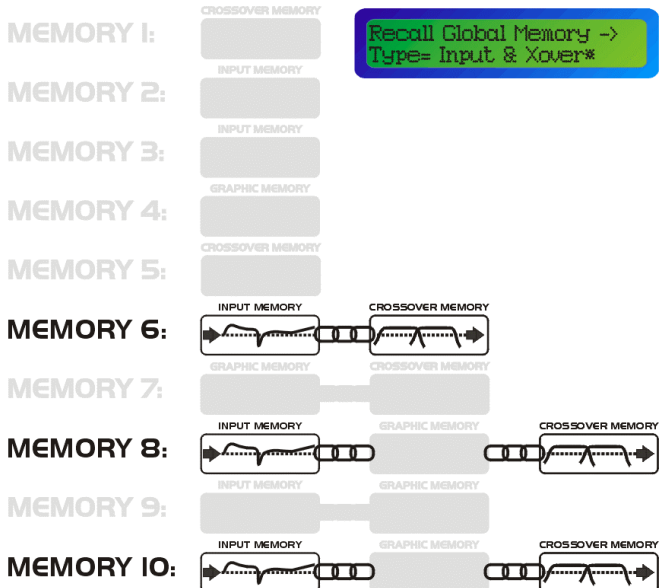

Recall Global Memory ->
Type= Input & Xover*

Note that storage and erasure of memories does not follow quite the same rules, being simpler in its operation.

Selecting Input and Crossover during a Store will skip any memories that have other combinations in them.

Selecting Erase for any combination will show only locations that have EXACTLY that combination – it is not possible to erase just one part of a combination memory.

The **4 Series** have 256 memory locations, but these are dynamic in nature – obviously a memory containing Input, Graphic and Crossover settings takes up more space than one containing just Input settings. Storage of 56 memories containing Input, Graphic and Crossover settings is possible.

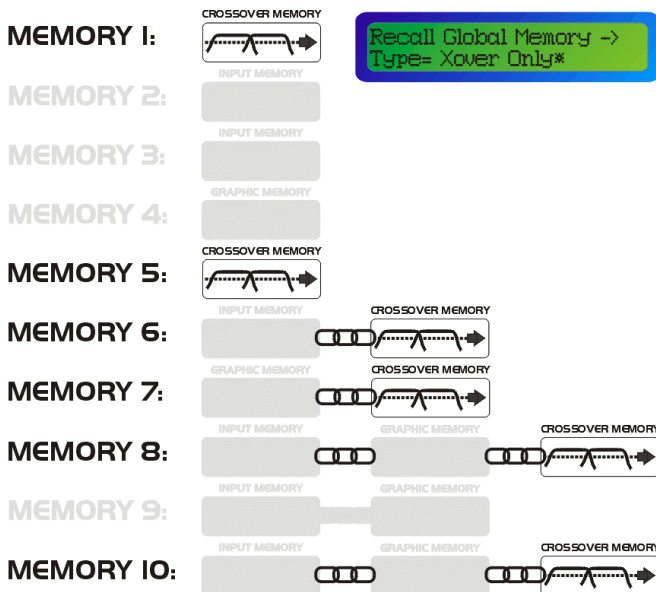

Recall Global Memory ->
Type= Xover Only*



Remote Control Interface Operation

XTA has a range of tried and tested interfaces, all of which are listed in the XTA Interface Guide, available from our website. We can supply all the interfaces described in this guide directly – please get in touch.

RS232 Interface

This interface is fitted as standard to all units and is accessed via the 9-pin D-type connector on the rear of the unit. Note that to connect to a computer's COM (serial) port correctly, a one-to-one cable must be used, and NOT a 'null modem' cable. A 'null modem' cable has the 'transmit' and 'receive' wires swapped over and will not work.

The RS232 connection is suitable for distances of about a maximum of 25 feet between the PC and the unit. If you experience problems with the connections, consider

- selecting a slower baud rate
- selecting the 'Use Acknowledge Cmd' option in AudioCore (see the Remote Menu > RS232 Configuration window)
- running the unit via the RS485 interface

Note that only one unit at a time may be connected to the computer via this interface. Additional units may be 'daisy-chained' via the RS485 connections from the back of the first one (it acting as a converter for them), but their RS232 ports are not used.

RS232 Connection (Single Unit)

A typical interface set-up might involve running an RS232 link from laptop or a desktop computer to a **4 Series** unit set up as a master unit. The diagram below shows this method of connection, the required menu options are also given. Note that the RS232 cable must be a 1-1 connection type, NOT a null modem cable (which has connections crossed internally).

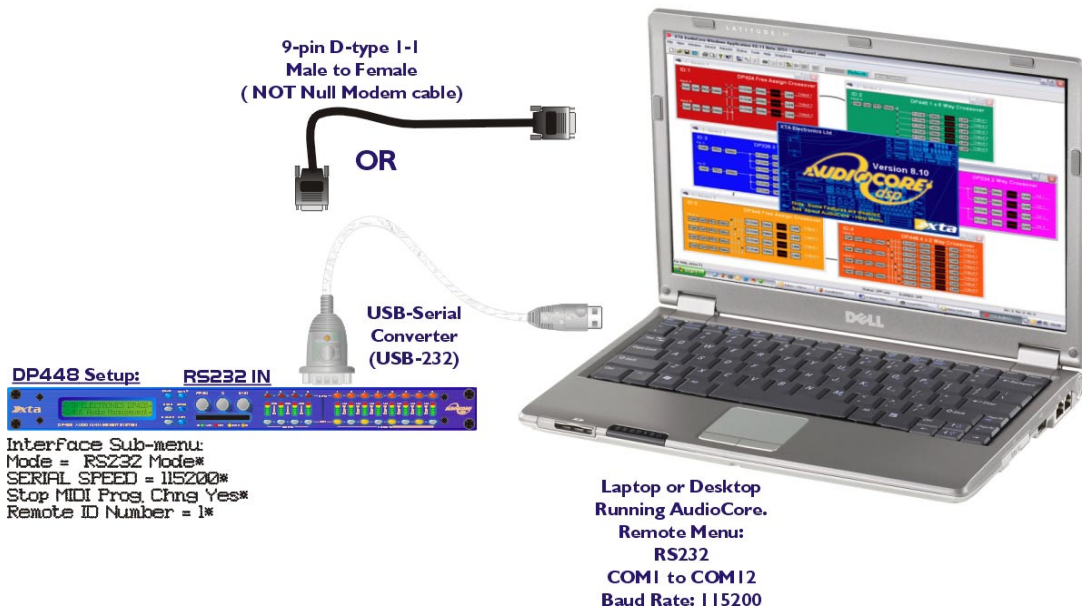

Loading New Software via a PC

The unit's internal software may be updated via the RS232 port **ONLY**, one unit at a time. We recommend disconnecting all other devices when updating the software.

The unit's interface must be set as RS232 Master on ID1 for the PC loader program to recognise it and allow the update to be sent.

Download the latest version of the loader program and the unit software from www.xta.co.uk, and follow the instructions included with this zip file. An RSS feed is available on the website to ensure immediate notification of software releases.

RS232 Connection (Multiple Units)

If control over multiple units is required, typically the slaves will be set up to run from the RS485 ports on the master unit. Note the incremental 'ID NUMBER' option in the unit's interface setup.

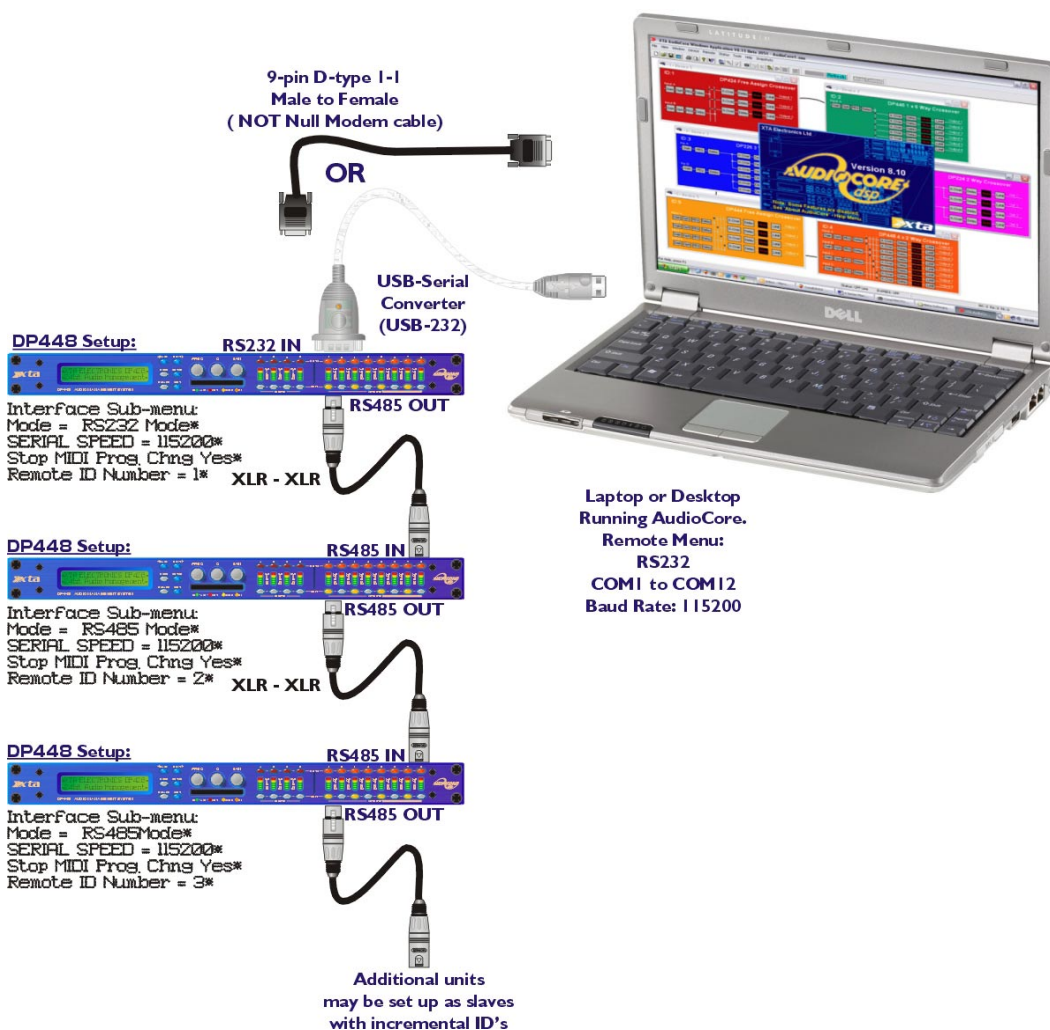

Shadow ID Numbers

Shadow ID numbers allow extra units to share the same ID and follow the settings of the 'main' ID. This is useful for larger systems (for example anything above a 4-way stereo system) where it is only necessary to set up one side of the system, and allow the other unit to track it identically.

Using the shadow IDs in this way also reduces the apparent system complexity within AudioCore. **This is due to the fact that shadow ID's NEVER send back any settings to AudioCore and because of this will NOT appear in the list of connected units.**

They can be thought of as listening to and acting upon all information addressed to them, but not replying. Up to 128 shadow units may be connected and assigned the same ID as the 'main' unit, but remember that the maximum total units on any one RS485 network is 128.

Shadow ID numbers are accessible when the unit's interface is configured, and will appear after ID number 128, starting from 1 again, but designated shadow IDs with an 's' after the number – 128s. Any ID can have multiple corresponding shadows.

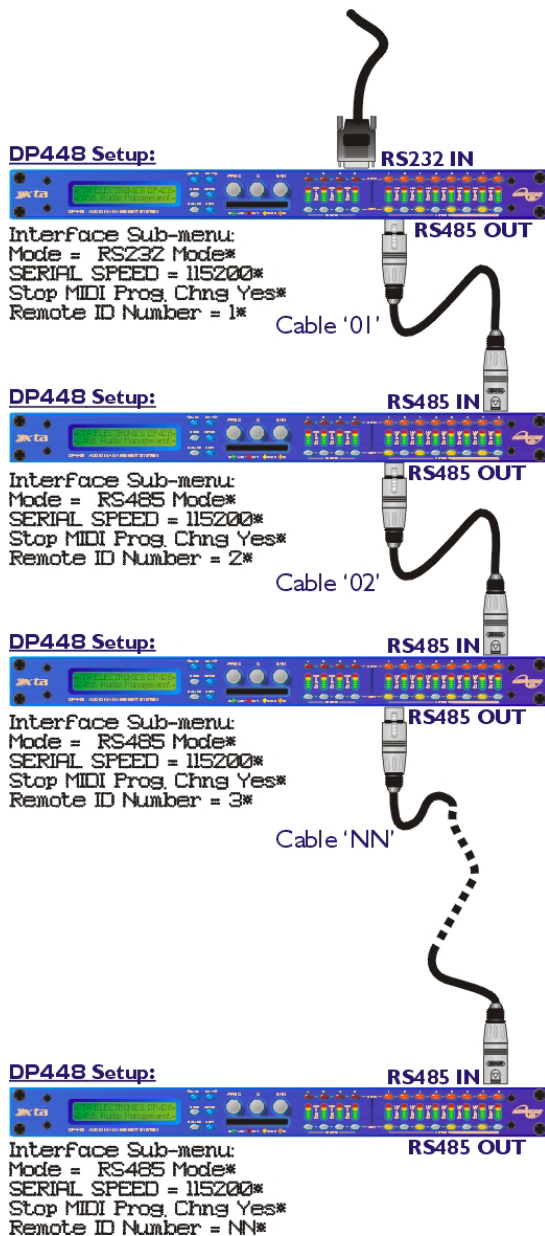

RS485 Interface

This interface is fitted as standard to all units and is accessed via the 3-pin XLR sockets on the rear of the unit. Cables to connect units together or to an RS232-485 converter will need to be wired one-to-one. We recommend the use of standard shielded microphone cables, or a balanced feed from a multicore.

RS485 is a fully balanced system, capable of sending data over distances of up to one kilometre. Note, however, that this is the **total** length of connection. The RS485 output of each unit is purely hardwired from the input and so no electrical regeneration of the signal is provided. What this means is that the distance from the **first** RS485 output to the **last** RS485 input must not exceed 1km in total.

As this diagram illustrates –
The combined length of cables 01 + 02 + ...NN < 1000 metres.

Note that this includes any units set up as shadow IDs.

Units may be connected in a star configuration if required, so a long cable may be used and then a hub formed with units all connected to this, but we do not recommend daisy chaining these configurations together.

XTA has a range of tried and tested interfaces, all of which are listed in the XTA Interface Guide, available from our website. We can supply all the interfaces described in this guide directly – please get in touch.



RS485 Connection

To use RS485 communication directly from a computer, a master unit must be configured to receive RS485. You must have a suitable RS485 port on your computer, or a converter connected to the serial port in use. This configuration is shown below, along with the required unit setup.

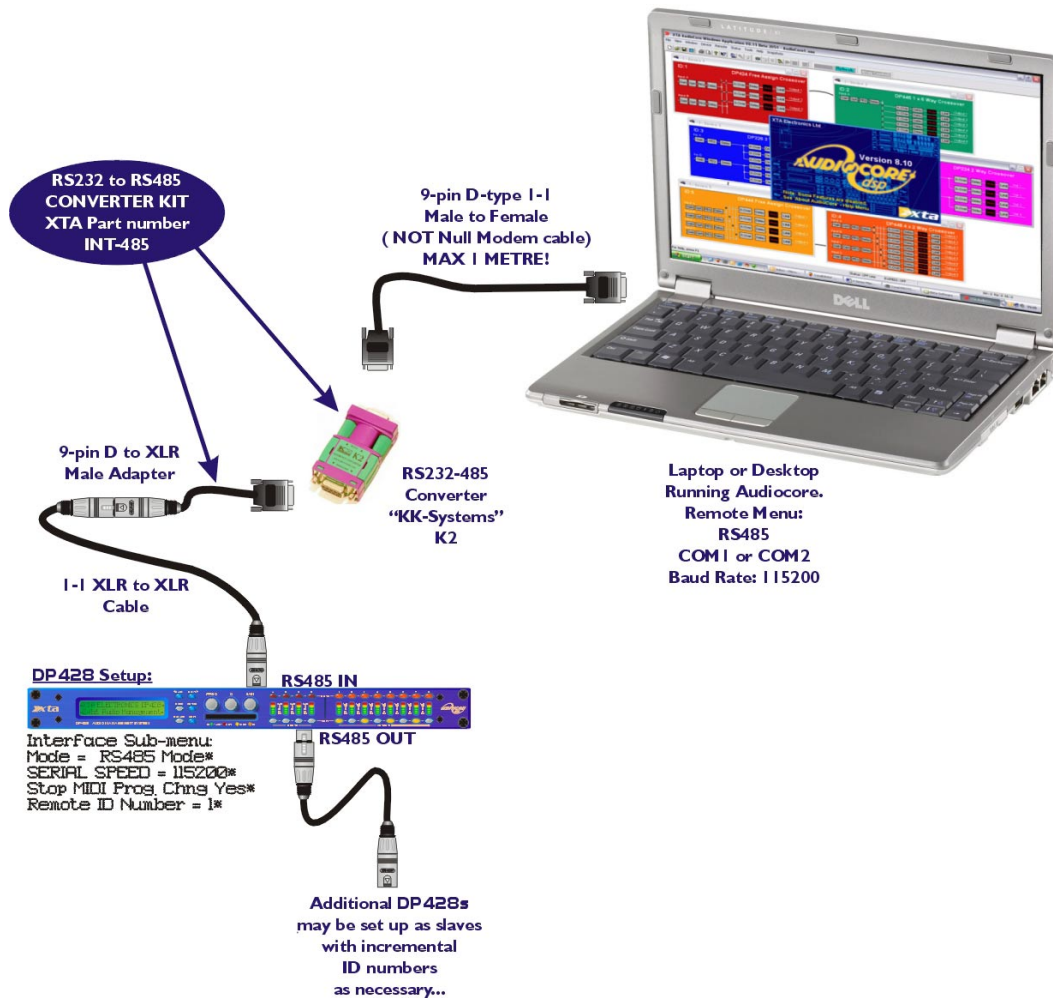

Both the converter and the required adapter cables are available from XTA. The adapter is available in a kit, which includes an RJ-45 adapter, the XLR to 9-pin adapter, and the converter itself. This complete kit is part number **INT-485**.

If you need to make up one of the XLR to 9-pin adapters, the pin-out is:

XLR	D-type
1	1
2	3
3	8



If your laptop or PC does not have a spare serial port (or any serial ports for that matter!), the RS485 converter must be connected through a USB – Serial converter. The RS485 converter that XTA recommend is available in two types – the standard K2, and the more advanced K2-ADE version. **Only K2-ADE version will work with USB-Serial converters**, as these converters do not support the extra handshake lines used with the standard converter.

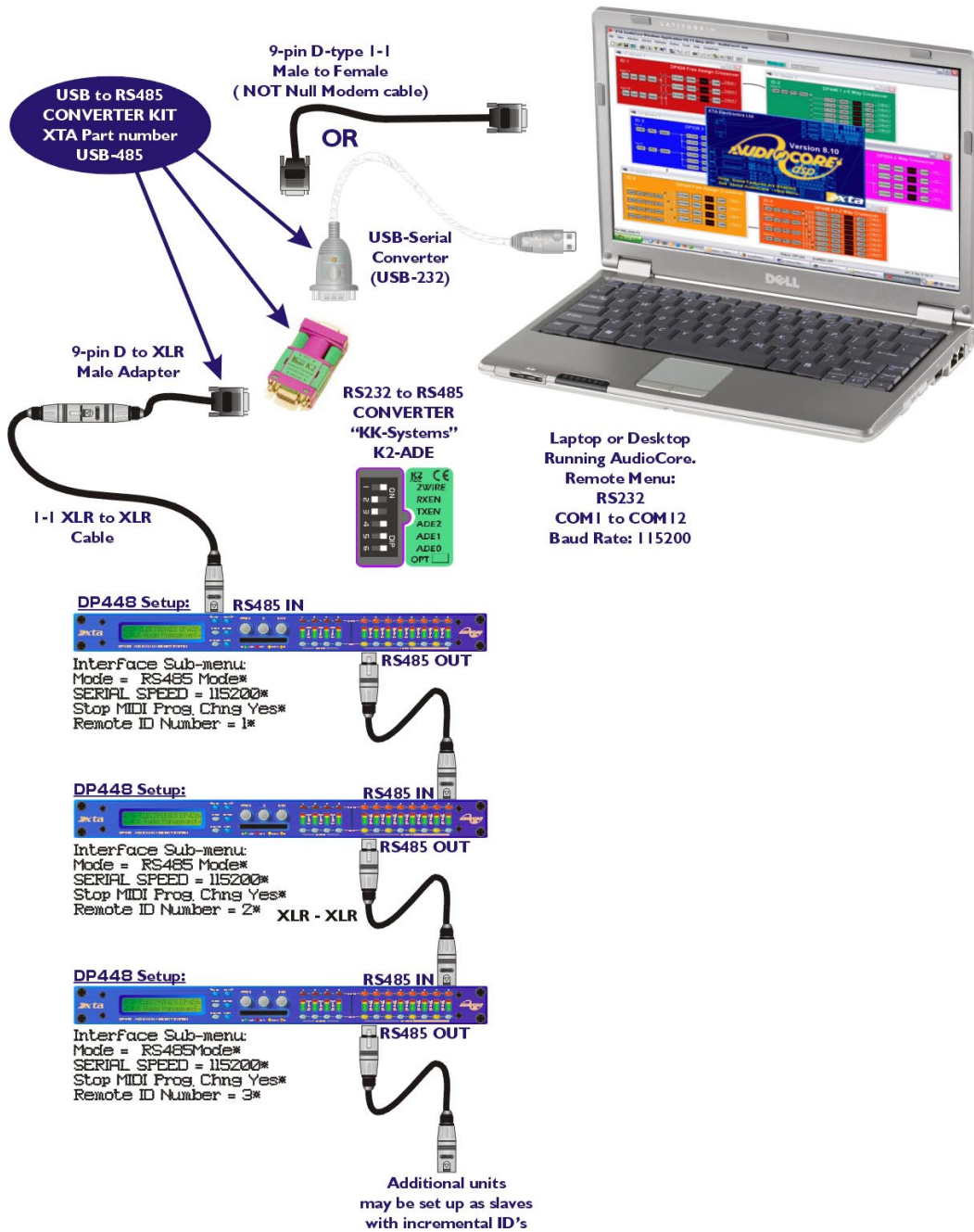

Both the converters and the required adapter cables are available from XTA. The adapter is available in a kit, which includes a USB-Serial converter, the XLR to 9-pin adapter, and the K2-ADE converter itself. This complete kit is part number **USB-485**. XTA has a range of tried and tested interfaces, including USB and wireless solutions, all of which are listed in the XTA Interface Guide, available from our website. We can supply all the interfaces described in this guide directly – please get in touch.

If a DP224/6 receives a MIDI Start or Stop command (used to mute / unmute all outputs) it will relay this message on the RS485 port to any connected units. The 4 Series units will respond to this message even though it cannot directly receive MIDI commands, due to not having a MIDI interface ;)



AES Inputs and Outputs

The **4 Series** units have a full AES implementation built in as standard. This allows the unit to both receive digital audio directly, and to transmit digital audio on to other devices. The switching of input and output can be performed independently, and the inclusion of sample rate converters on the inputs allows the unit to accept sample rates from 32kHz up to 192kHz.

AES Input

Input selection is via a recessed switch on the rear panel of the unit, between input D and output 1. A red LED inside this aperture illuminates to show that the AES digital inputs have been selected.

A complimentary LED on the front panel below the PCMCIA card also illuminates. The switch controls the rear panel LED directly, whilst the front panel one is via the processor, allowing it to relay a little more information.

If it is flashing, this means that AES inputs have been selected but have not locked. Once a stable AES signal is being received, it will be permanently illuminated.

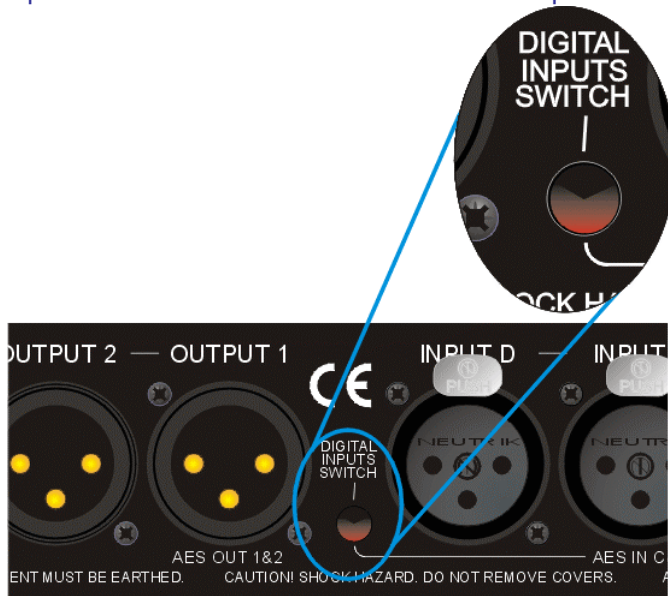

**The AES inputs are marked on the rear panel –
for channels A & B use input A,
and for channels C & D use input C.**

AES Output



AES outputs are selected through the AES menu:

```
AES/EBU Sub Menu  
Output Selection
```

Pressing **ENTER** and then using **BACK** and **NEXT** chooses either Analogue or Digital. Press **ENTER** again to confirm selection.

**The AES outputs are marked on the rear panel –
Channels 1 & 2 use Output 1
Channels 3 & 4 use Output 3
Channels 5 & 6 use Output 5
Channels 7 & 8 use Output 7.**



AES Diagnostics and Status Information

Also under the AES/EBU Sub Menu is the AES Status InFormation option, which can be used to check the incoming sample rate(s) and confirm that the data is being received correctly.

Pressing **ENTER** will first show

```
AES Device Status
V1: E  V2: E  V3: A
```

This display shows the correct operation of the three AES transmitters V1, V2 and V3. The letter after each is the silicon version (and is of no importance to the user).

Pressing **ENTER** again will show

```
AES Device Status
V : 96k0  V : 96k0
```

This display shows the status of the two AES receivers, input A on the left, and Input C on the right. The sample rate the unit has been able to lock to is shown, or **UNLOCKED** will be displayed in its place. The unit will lock to sample rates from 32kHz up to and including 192kHz.

The unit's own processing sample rate is 96kHz, and AES output data is always at 96kHz. Internal sample rate converters will translate all incoming rates to 96kHz – one converter for each AES input. This allows the two input streams to be at different rates if necessary.



Security and Locking

After selecting the Security Sub Menu and pressing **ENTER**, select one of the lock types, choosing the most appropriate one for your application. As ever, **ENTER** will confirm your selection.

User Specific

Upon pressing **ENTER** to select this type of lock, each parameter group is presented in turn. Choose the type of lock (as above) using the **FREQ** encoder, and press **ENTER** to confirm each parameter. After the last parameter, the unit requests a password. The description of this operation is given at the end of this section.

This option allows the user to specify, for each type of parameter, whether it is to be completely accessible ('No Lock'), viewable but not adjustable ('Control'), or effectively unavailable ('Display'). The ability to operate mutes, store or recall memories, or even access the menus may also be locked.

Xover Only

All input parameters are available, but only the gain trim (± 6 dB) is available on the outputs, effectively locking all the crossover settings. All mutes remain active.

Xover + Trim

All input parameters available, but no output parameters – the crossover sections are completely locked. All mutes remain active.

Xover + Trim + Mute

As for 'Xover + Trim' but additionally, output mutes are locked. Input mutes remain active.

Changes Only

All parameters may be viewed, but none may be adjusted. This applies to both inputs and outputs. All mutes remain active.

Changes + Views

No parameters are accessible – in effect the **EDIT** keys do nothing. All mutes remain active.

Changes + Mutes

All parameters may be viewed, but none may be adjusted. This applies to both inputs and outputs. All mutes are also locked.

EVERYTHING

No parameters are accessible – in effect the **EDIT** and **MUTE** keys do nothing.

Entering the Password to Complete the Locking Operation

After selection of the lock type from the list above, a four-digit security code will be asked for. This can be entered by using the **FREQ** control to select a character, and the **BACK** and **NEXT** keys to move to the next character.

Alternatively, the **EDIT** keys can be used to enter a code by pressing any combination of the eight buttons. Each **EDIT** key represents its channel labelling, so any combination of **A, B, C, D, 1, 2, 3, 4, 5, 6, 7** and **8** can be used as a code, as shown below. Press **ENTER** to accept code and then re-enter it to confirm.

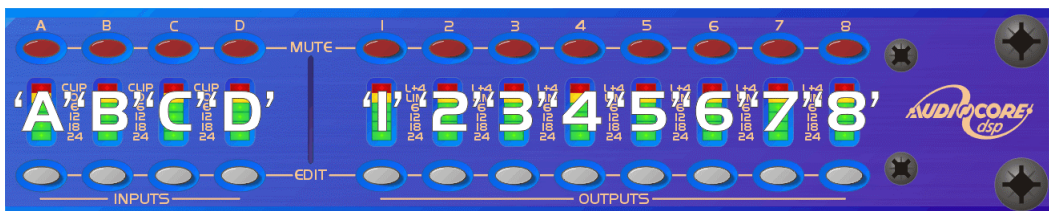

To prevent external computer control being used to adjust locked settings, be sure to set the external interface to **OFF** before locking out the unit.



Unlocking the Unit

To unlock the unit press **ENTER** and then type the code in. This can be entered by using the **FREQ** control to select a character, and the **BACK** and **NEXT** keys to move to the next character. Alternatively, the **EDIT** keys can be used to enter a code by pressing any combination of the eight buttons. Each **EDIT** key represents its channel labelling, as described in the locking section.

Forgotten the Password?

Don't panic! Your unit can still be unlocked. In an attempt to improve the security system on the **4 Series**, and prevent a standard master password from becoming common knowledge, the units now have a random password key generator.

The procedure for unlocking a unit using the password override is explained below:

Switch the unit on with the **MENU** key held in momentarily. After a few seconds, the unit will ask for a security code. Use the **EDIT** keys in the same manner as for entering lock codes (see page 33 for details) and enter 2121.

The display will show:

```
Enter XTA Supplied Code:  
Break Code = 12345 [NNNN]
```

The Break Code (in the example 12345) should be noted and supplied to XTA. We have software to generate the corresponding Pass Code which should be typed in, followed by **ENTER**. This will unlock the unit and wipe the previous password.

Note the following about this procedure:

Once the Break Code has been noted, do **NOT** press **MENU** again during the operation of the unit (except to get back to this point on power up), or a different code will be generated. The unit may be used as normal, but every press of **MENU** will change the Break Code, so the Pass Code XTA supply will not work!

The unit may be switched on and off as necessary – just be sure **NOT** to press **MENU**, or the entire Break Code procedure will have to be repeated.



Unit Cloning

The unit cloning feature allows the entire “personality” of the unit to be copied onto a PC card for backup purposes, or so another unit can be instantly reconfigured to operate identically. This will include all user memories, and all user selectable menu options. Note that OEM presets will not be copied – use the procedure below to copy preset files.

Select **Unit Cloning** from the **SYSTEM Sub-Menu** and then choose to **Store** or **Recall** the cloning information as appropriate. The unit will reboot after the recall procedure.

Copying Unit Software and Preset Files

It is possible to copy the operating software or preset file (or both) onto a PCMCIA card to allow this data to be used in another unit. This procedure is not part of the standard menu system, and must be initiated on power-on with a special key sequence.

Copying Data from Source Unit

Switch the unit on with the **MENU** key held in momentarily. After a few seconds, the unit will ask for a security code. Use the **EDIT** keys in the same manner as for entering lock codes (see page 33 for details) and enter the following code:

1AB4 to copy the software only;
3AB4 to copy the presets only;
2BB2 to copy the software and the presets.

Be sure to set the Write Protect switch on the card **ON** before removal, as data corruption can occur as the card is pulled out of the slot.

Loading Data into Destination Unit

If the unit is already running, copy the software /presets as explained previously on page 33.

Cold Start Reboot Procedure

Xta ALERT Please only undertake this procedure if you are confident with internal workings of electronic devices – dangerous voltages exist internally and XTA cannot be held responsible for any damage caused to the unit, or user. If you are in any doubt about what to do, please call us and we can talk you through the process, or return the unit to your local distributor.

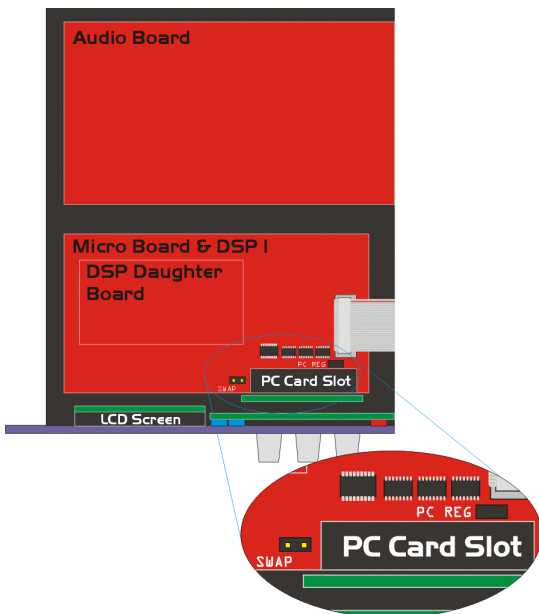

This procedure explains how to reboot a unit and load new software when there has been a problem during a remote download (for instance the PC has crashed or the unit was switched off during the update).

Take the top cover off the destination unit, taking care NOT to touch the power supply or mains inlet. Move the link marked PC REG to the location marked SWAP.

Insert the PC card containing the software and switch the unit on.

It should boot up and display **Erasing Flash** then begin loading the new software. The process is complete it will prompt for the link to be put back to PC REG. Remove the card and switch the unit off and on again. If successful, it will boot up normally and display **New Software**.

Make sure the link is put back on PC REG or the card slot will not function. Replace the cover.



Advanced Audio Features

Graphic Equaliser Behaviour

Each input of the **4 Series** units has a 28 band graphic equaliser, allowing “traditional” manipulation of the frequency response in a manner immediately familiar and accessible to all users. The behaviour of the equaliser may be adjusted to produce an effect similar to either the GQ600, or a “Special” type of response. Both types will be explained in this section, and what primarily makes them sound as they do. XTA’s AudioCore software has been used in the following screenshots.

The “GQ600” behaviour

The GQ600 behaviour is designed to offer the “best of both worlds” in terms of corrective control and creative control. This is achieved by manipulation of the bandwidth of the filters, depending on the amount of cut or boost being applied. At low levels of cut/boost (where it would be safe to assume the changes to the EQ are mainly for creative use) the bandwidth is wider, so the changes to the overall response are gentler.

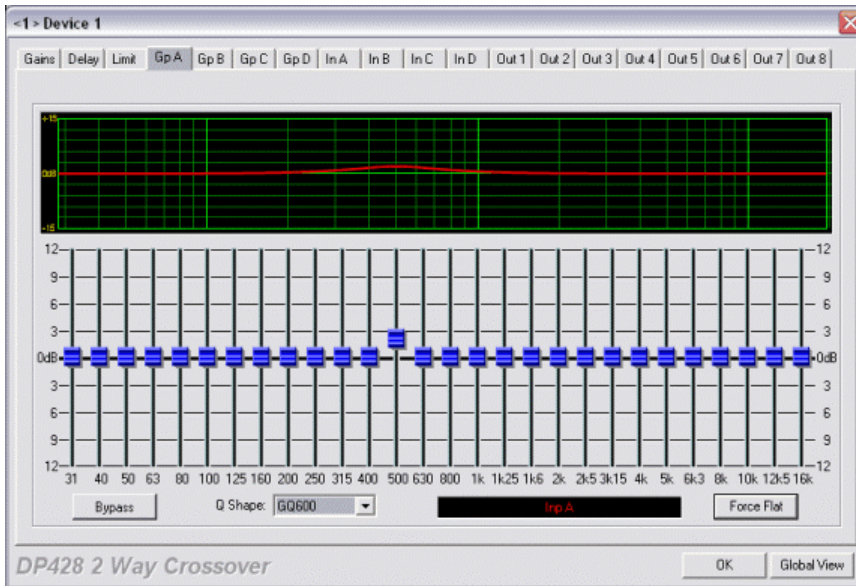

As can be seen by this example, the 500Hz band has been boosted by 2dB, and the bandwidth that has been affected is quite wide (there is still appreciable activity an octave on either side of 500Hz – 250Hz and 1kHz).

Looking at the response when the band is boosted to +8dB reveals a narrowing of the affected range of frequencies.

The narrowing of the bandwidth allows more precise control when trying to pinpoint and correct anomalies in the response.

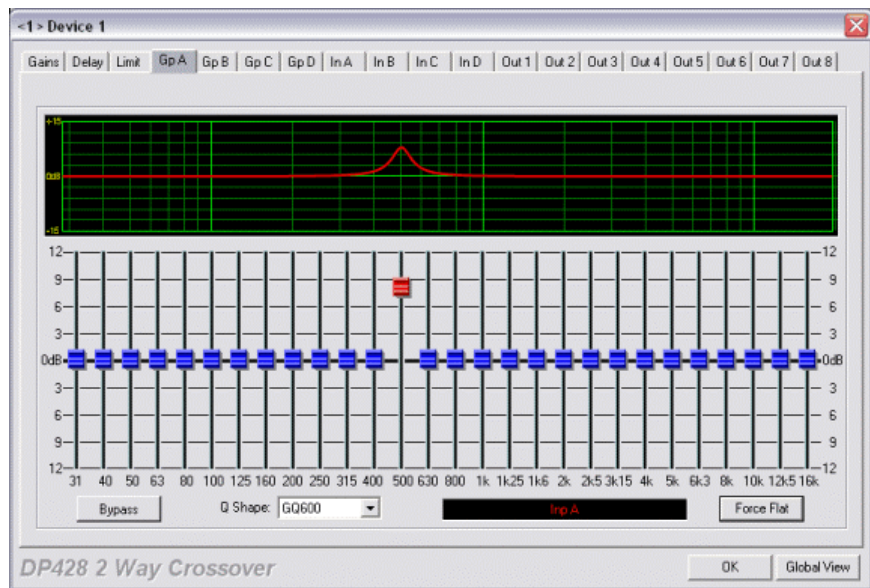

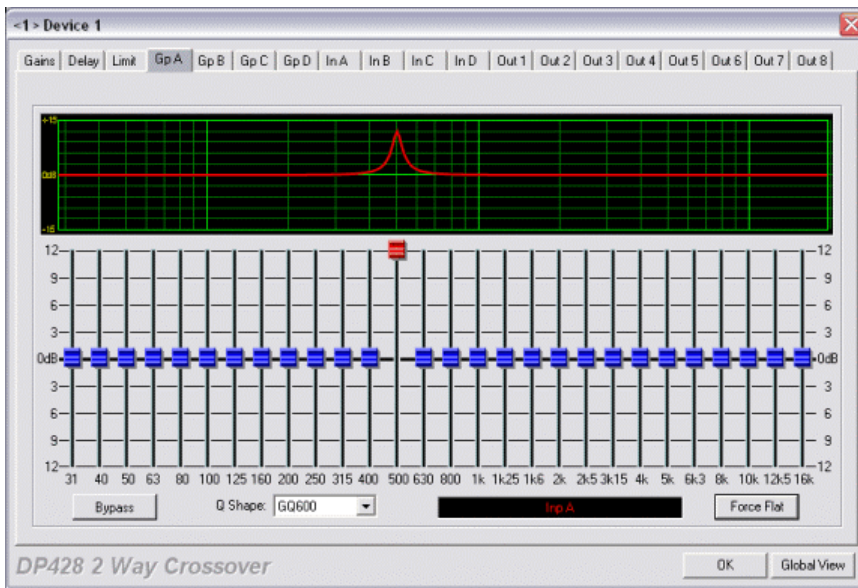

When the band is boosted to its maximum value, it can be seen that the response has become quite narrow. This is useful when cutting bands (for example to remove troublesome feedback resonances) as it has less effect on the surrounding areas.

The “Special” behaviour

The “Special” behaviour is designed to offer a more constant ‘Q’ type response, which means there is less variation of the filter bandwidth at different cut/boost levels. This leads to a more “rippled” response at low values of cut/boost, but is also less “peaky” when high levels of boost are applied ensuring the flattest response when adjacent faders are adjusted.

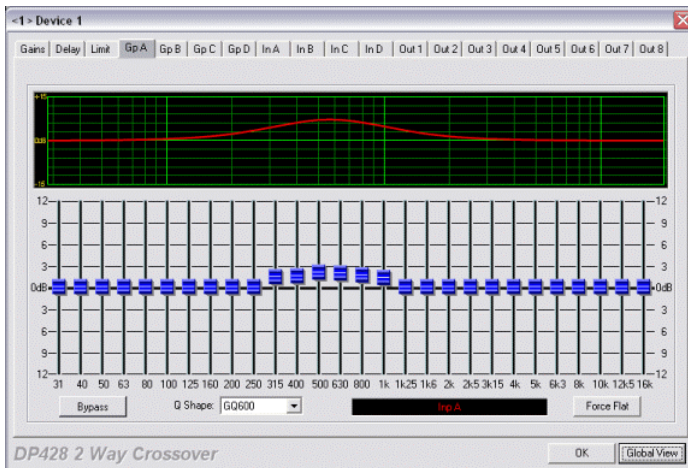

Consider the group of faders gently boosted as shown below, with the “GQ600” behaviour selected. As can be seen, the filters’ responses have combined to give a smooth lift in response across the entire region. The overall level is considerably higher than the individual amount of boost applied to any single band.

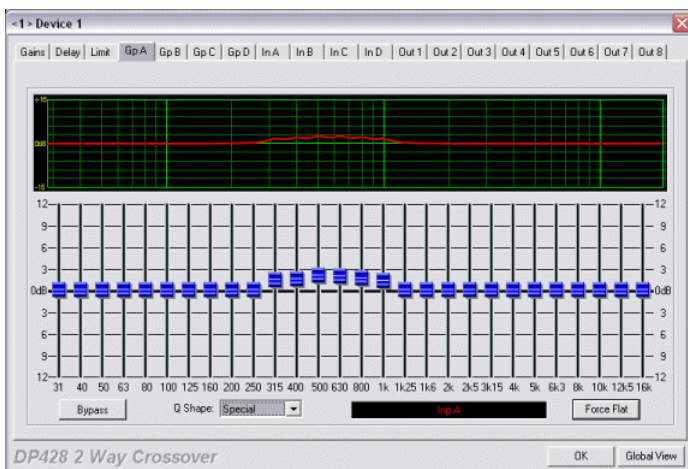

The same bands have been boosted in the example below this, but the behaviour has been set to “Special”. The ripple in between bands is now obvious, due to the bandwidth not having widened at low level boosts. However, the overall level is much closer to the highest maximum filter’s boost.



Program Limiter and “D-Max” Limiter

The **4 Series** units have two levels of dynamic protection on its outputs – a traditional program limiter, and a newly introduced “D-Max” limiter.

Program Limiter

High performance digital limiters are provided for each output with control over attack time, release time and threshold parameters - see page 39 for details. This level of control allows the user to balance the required subjective quality of the limiter against the driver protection requirements. It does also mean that an incorrectly set limiter may sound awful! In particular, as with all limiters, using too fast an attack or release time will result in excessive low frequency distortion. In the **Design a Crossover** sub-menu there is an option for automatic limiter time constants. Use this option if you are unsure how to set the time constants manually. XTA recommend the use of the automatic setting.

In this mode the time constants will be automatically set from the High-Pass filter frequency according to the table below.

The time constants are set by the high pass filter frequency for that channel.

High Pass Filter	Auto Attack Time	Release Time
< 10Hz – 31Hz	45mS	x16 (720mS)
31Hz – 63Hz	16mS	x16 (256mS)
63Hz – 125Hz	8mS	x16 (128mS)
125Hz – 250Hz	4mS	x16 (64mS)
250Hz – 500Hz	2mS	x16 (32mS)
500Hz - 1kHz	1mS	x16 (16mS)
1kHz – 2kHz	0.5mS	x16 (8mS)
2kHz – 32kHz	0.3mS	x16 (4mS)



“D-Max” Clip Limiter

The main limitation with traditional dynamics control is the inability of the processing to react truly instantaneously to the signal. One of the most significant advantages of digital signal processing over analogue is the ability to delay the audio signal precisely and without extensive complex hardware. The entire domain of digital signal processing is based around the combination of delaying, multiplying, and accumulating numbers (representing samples of audio) to implement all the filters and dynamics processing we have come to expect today.

In the case of dynamics processing, being able to delay a signal allows the processor module to delay the main signal in relation to the sidechain (the signal being monitored relative to the threshold), so that it can compensate for peaks prior to the arrival of the main signal.

Consider the situation of a monitor engineer listening to a band perform. Having no access to dynamics processors, he has had to resort to manually ‘riding the faders’ in an attempt to keep control of the levels. Should the level of one of the channels on his desk reach an unacceptably high level, he will turn it down appropriately.

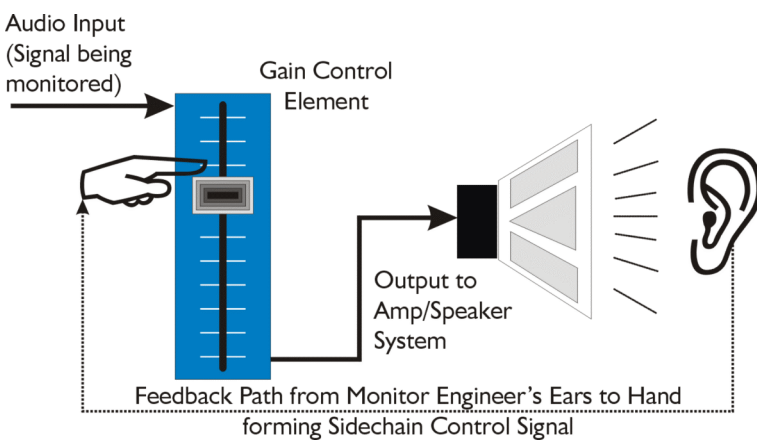

There is a hidden sidechain in operation even in this case. The main signal path is fed through the monitor desk and the gain controlled by adjusting the fader. The sidechain is formed by the feedback path between the engineer’s ears checking the level and his brain instructing his hand to turn the fader down if the volume goes over the threshold he has chosen.

In this case, the delay between the signal actually going over the threshold, the engineer registering the situation, and then turning the signal down will be in the order of several hundred milliseconds at best. This will only be true if he is not distracted – in reality, it may be several seconds before any gain reduction is imposed on the signal to bring it under control.

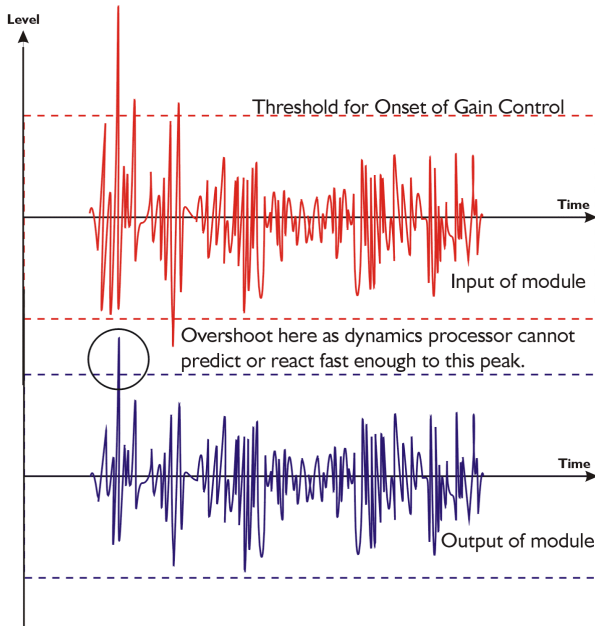

For an analogue dynamics processor, the situation is much better. Controlling the gain electronically, and not relying on a human sidechain feedback mechanism, it can react much more quickly.

The red waveform represents the input to the dynamics module, with the dotted line showing the threshold for gain control to occur. There are several peaks towards the start of this signal that are above the threshold, and so the dynamics processing should react to these as appropriate. (In this case reduce the gain).

The blue waveform shows the output of the dynamics module. The circled peak demonstrates that the processor has missed the first peak above the threshold (as it is very fast and short), but has ‘caught up’ shortly afterwards, keeping all other peaks under control. As it is unable to predict what is coming, this will always be a failing with analogue dynamics processing.



The **4 Series**'s "D-Max" limiter predelayes the sidechain signal, resulting in a "zero overshoot" limiter, which is able to catch all peaks and provide a reliable absolute maximum setting for the output of any channel.

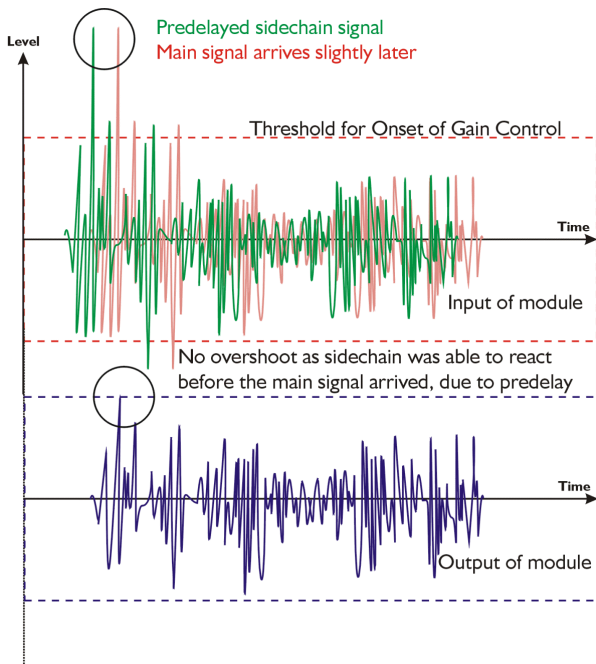

The predelayed sidechain is shown in green, with the main signal in red. As the main signal arrives slightly after the sidechain, the output from the unit does not suffer from the overshoot problem.

Remember that this delay is only in the order of tens of uS, and is a **predelay** – the sidechain is moved **back** in time in relation to the main signal. Inserting a delay into the **main** signal path of an analogue dynamics processor will achieve similar results, but with the penalty of delaying the main signal by the amount of look ahead delay introduced.

The "D-Max" limiter which appears in output lists just following the traditional limiter, has only two parameters to adjust:

```
OP1 Output 1 ClipLim
Rel.= Medium 10dB Above
```

The release time (either **Fast**, **Medium**, or **Slow**) and the threshold. Note that the threshold is set to be a minimum of 2dB above the threshold of the program limiter – setting the threshold to **10dB Above**, as in the example, means that no more than 10dB of overshoot above the threshold of the program limiter will ever be allowed.

The release time may also be set to follow the High Pass filter of the output – this is achieved through the **Design a Crossover** sub-menu, and will result in the display changing to show

```
OP1 Output 1 ClipLim
Rel.= Auto 10dB Above
```



Setting Accurate Limiter Thresholds

The limiters built into the **4 Series** are intended to be used for loudspeaker driver protection, as opposed to amplifier protection. All modern professional power amplifiers designed for live sound use have their own limiters, which are tailored to protecting the amplifier from clipping.

The following section describes how to set up the units' limiters to provide exceptional protection against driver overheating, and cone over-exursion.

Most speaker systems are given a power rating in Watts RMS. This is the maximum continuous power that the system will handle and often appears very conservative. In reality, as music program is far from continuous in nature, the peak power of the system is much higher – up to ten times the continuous figure. Any limiter, which is to protect the driver from damage, must be able to fulfil the following tasks.

- Have an attack time which is calculated to allow transients through but keep the RMS level below the speaker manufacturers specification;
- Have a release time which is sufficiently long to avoid the limiter itself modulating the program;
- Be intelligent enough to adjust the envelope of the limiter according to the frequency content of the program material.

The program limiters are capable of performing all these tasks. The only parameter that the user must set manually is the threshold, and it is crucial that this is done correctly. Consider the table below.

dB	Ratio	Vrms	Pwr 8 Ω	Pwr 4 Ω	Pwr 2 Ω
45	177.83	137.74	2371.71	4743.42	9486.83
44	158.49	122.77	1883.91	3767.83	7535.66
43	141.25	109.41	1496.45	2992.89	5985.79
42	125.89	97.52	1188.67	2377.34	4754.68
41	112.20	86.91	944.19	1888.39	3776.78
40	100.00	77.46	750.00	1500.00	3000.00
39	89.13	69.04	595.75	1191.49	2382.98
38	79.43	61.53	473.22	946.44	1892.87
37	70.79	54.84	375.89	751.78	1503.56
36	63.10	48.87	298.58	597.16	1194.32
35	56.23	43.56	237.17	474.34	948.68
34	50.12	38.82	188.39	376.78	753.57
33	44.67	34.60	149.64	299.29	598.58
32	39.81	30.84	118.87	237.73	475.47
31	35.48	27.48	94.42	188.84	377.68
30	31.62	24.49	75.00	150.00	300.00

Using this table it is a straightforward procedure to work out the required setting of the limiter thresholds for the system.

- ✓ First, check the RMS power rating of the speaker system, and its impedance.
- ✓ Look up this value in the table above, using the closest value below the rated power of the speaker system. Note the corresponding 'dB' value.
- ✓ Check the gain of your amplifier, which needs to be in 'dB'.
- ✓ Subtract this gain figure from the dB value obtained from the table to find the required absolute setting for the limiter thresholds.

Note that, for safety, always set the limiter threshold 1 or 2 dB below the maximum allowable worked out using the above method.



ALWAYS REFER TO YOUR SPEAKER MANUFACTURER FOR LIMITER SETTINGS.



Crossover Filter Slopes

It should also be noted that the turnover frequency displayed on the screen is the -3dB point for all types except Linkwitz-Riley where the -6dB point is shown. If the -6dB point is to be used for the Bessel or Butterworth filter, take the required crossover frequency, multiply this by the appropriate factor from the following table and then select the closest available frequency on the display.

Filter Type	High pass factors	Low pass factors
Bessel 12dB/Oct.	1.45	0.69
Butterworth 12dB/Oct.	1.31	0.76
Bessel 18dB/Oct.	1.37	0.73
Butterworth 18dB/Oct.	1.19	0.84
Bessel 24dB/Oct.	1.35	0.74
Butterworth 24dB/Oct.	1.15	0.87
Bessel 48dB/Oct.	1.39	0.72
Butterworth 48dB/Oct.	1.08	0.93

Please note that unlike conventional analogue crossovers, crossover points and slopes are set with absolute accuracy since component tolerance problems do not occur.

Please see page 18 for details of how to adjust the high and low pass crossover filter settings.

Time Alignment

A further advantage of the **4 Series** over conventional products is the provision of an independently adjustable delay section for each output. This allows the true arrival time from multiple drivers to be precisely aligned rather than relying on the compromise 'phase adjust' approach. Delay time is adjustable in 0.3µS steps (0.1mm). Please see page 17 for details of how to adjust the delay times.

To convert from units of time (i.e. milliseconds) to units of distance use the following formula:
1 millisecond = 343mm (1.126ft) @ 20°C (68°F)

To calculate time delay for a known distance, use:

$$\text{Time delay} = \frac{\text{Distance in meters}}{20.06 \times \sqrt{273 + ^\circ\text{C}}}$$

where °C is the temperature in °C.

To simplify this equation at 20°C.

$$\text{Delay time in milliseconds} = (\text{Distance in meters} \times 2.192) \text{ or } (\text{Distance in feet} \times 0.955)$$

Note: Centigrade = (Fahrenheit - 32) x 0.5555.



Parametric Filter Types and Their Uses

A wide selection of filter types has been made available under the PEQ section when editing input or output filters. Scrolling through the various filter types is achieved by repeated presses of the **ENTER** key. Note that this will only change filter types if the filter is **BYPASSED** or the **GAIN** set to 0dB. Bypassing the filter, then changing types using the **ENTER** key will automatically set the gain back to 0dB.

Each filter type will be explained in turn in the following section.

Standard Parametric EQ

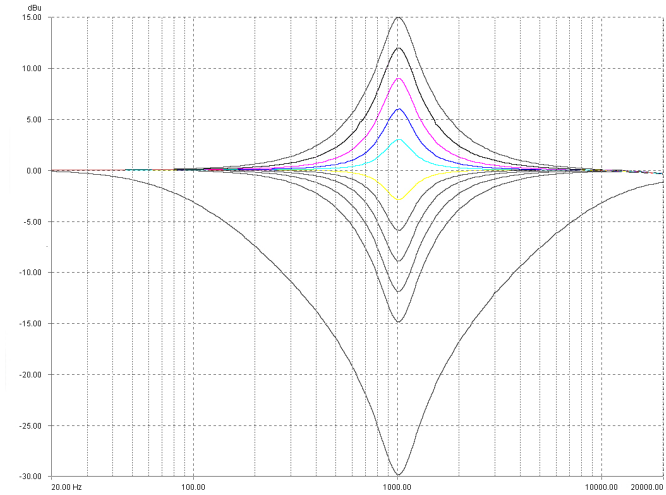

```
InA Input A FEQ:10
      1K00Hz Q=30 00dB
```

The standard parametric band has adjustable frequency, 'Q' (or Bandwidth) and Gain controls. These affect a range of frequencies symmetrically about the centre frequency as shown in the graph.

Various levels of cut and boost are shown to the left, along with various 'Q' settings (gain boosts only are shown below). Remember that 'Q' is 1/Bandwidth, so the higher the 'Q', the lower the Bandwidth, and the smaller the range of frequencies affected.

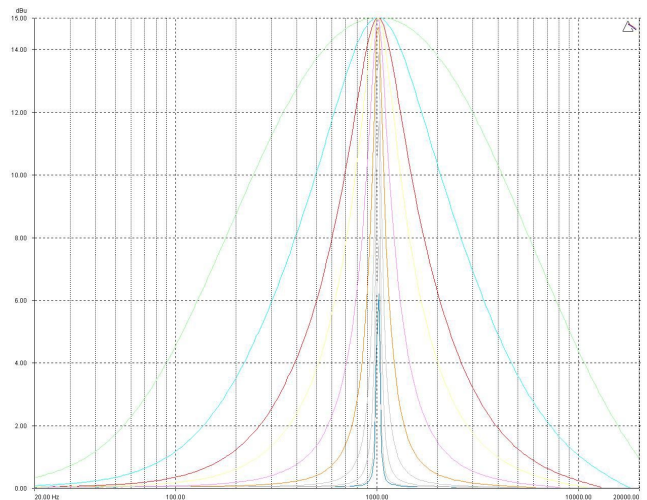

Shelving EQ (High Shelf shown)

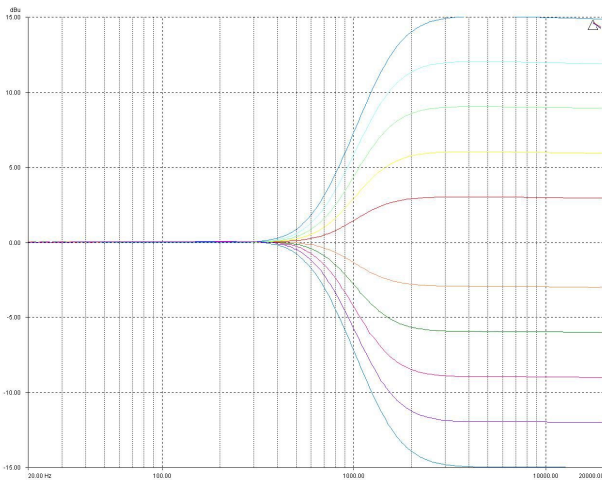

```
InA Input A HSF:1-C
1k00Hz Q=3.0 00dB
```

Remember – to change filter types, press **BYPASS** to bypass the filter, and then use **ENTER** to select the filter type.

The shelving EQ has adjustable frequency, 'Q' (or Bandwidth) and Gain controls. These affect a range of frequencies from the turnover frequency as shown in the graph. For a high shelf, frequencies above the turnover frequency will be affected. For a low shelf, frequencies below the turnover frequency will be affected.

Various levels of cut and boost are shown to the left, along with various 'Q' settings (gain boosts only are show below).

Remember that 'Q' is 1/Bandwidth, so the higher the 'Q', the lower the Bandwidth, and the smaller the range of frequencies affected.

Note that 'Q' settings above 0.75 will result in slight overshoot in the filter response (as seen at the highest setting to the right). This is normal behaviour and does not indicate instability.

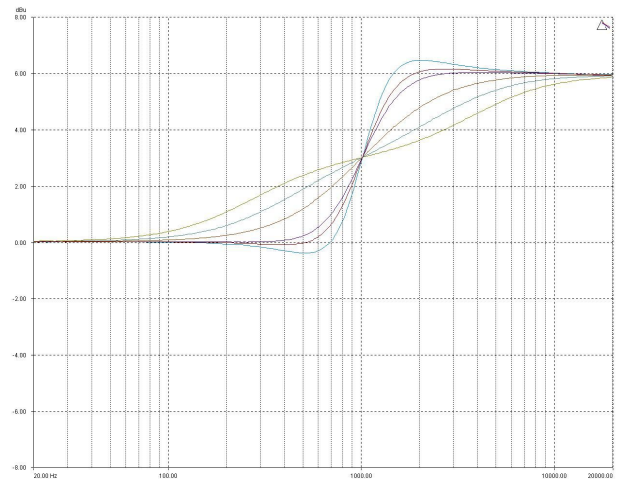

Creating a Flat-topped EQ Response

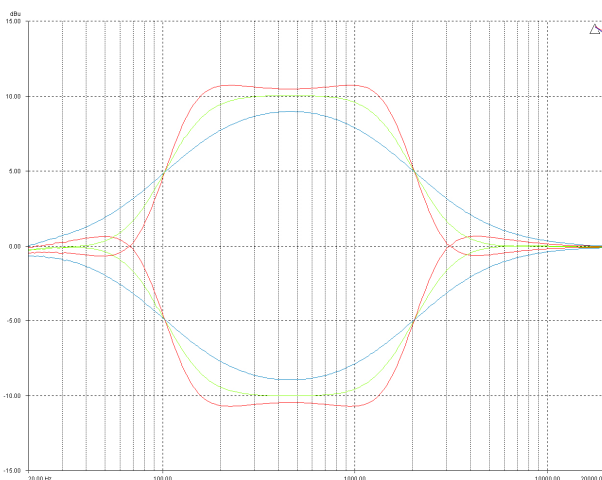

To create a flat-topped EQ filter response such as that shown to the left, use two EQ bands, BOTH configured as low shelves. For an overall BOOST, set the Lower frequency filter to BOOST the desired amount, and the Upper frequency filter to CUT by the same amount.

This example shows one filter at 100Hz and the other at 2kHz, with the 100Hz filter at -10dB, and the 2kHz filter at +10dB. Varying the 'Q' affects the slope of the response – values above 0.75 will cause overshoot as shown.

Assymetrical responses may be achieved by adjusting the 'Q' of each filter independantly.



Bandpass Filter

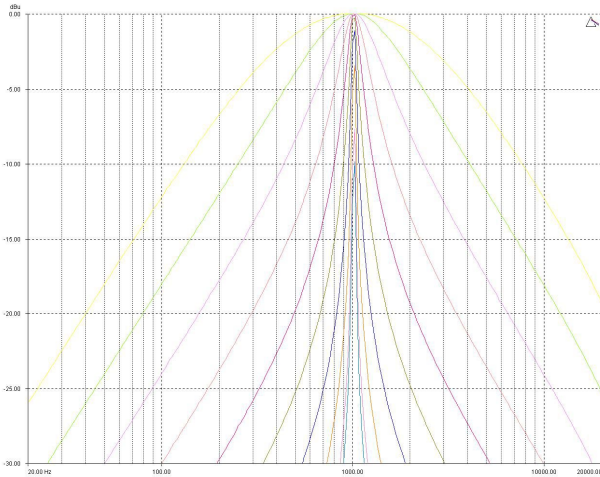

```
InA Input A BPS:1\
1K00Hz Q=30 Bandpass
```

Remember – to change filter types, press **BYPASS** to bypass the filter, and then use **ENTER** to select the filter type.

The bandpass filter has adjustable frequency and 'Q' (or Bandwidth) controls. These affect a range of frequencies symmetrically about the centre frequency as shown in the graph, gradually cutting the level, but providing no gain.

Remember that 'Q' is $1/\text{Bandwidth}$, so the higher the 'Q', the lower the Bandwidth, and the smaller the range of frequencies affected.

response (so it is not constructed from a high pass and low pass). See previous page for details of how to construct a flat-topped filter response.

Note that the response is fundamentally NOT a flat-topped pass (so it is not constructed from a high pass and low pass). See previous page for details of how to construct a flat-topped filter response.

Notch Filter

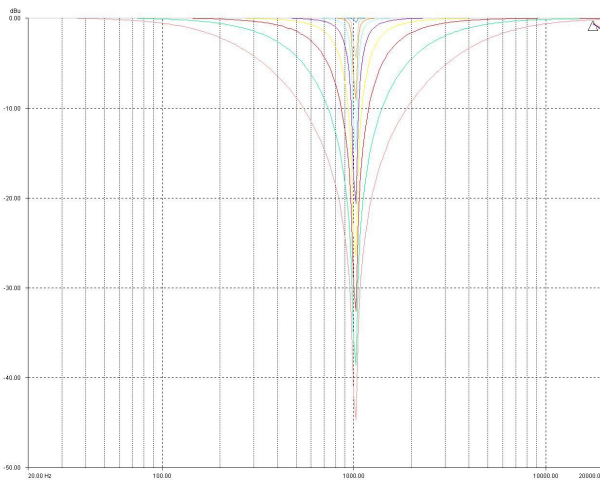

```
InA Input A NOT:1\
1K00Hz Q=0.75 Notch
```

Remember – to change filter types, press **BYPASS** to bypass the filter, and then use **ENTER** to select the filter type.

The notch filter has adjustable frequency and 'Q' (or Bandwidth) controls. These affect a range of frequencies symmetrically about the centre frequency as shown in the graph.

Remember that 'Q' is $1/\text{Bandwidth}$, so the higher the 'Q', the lower the Bandwidth, and the smaller the range of frequencies affected. The notch filter depth varies with bandwidth – the wider the filter, the lower the depth will be.



All Pass Filter

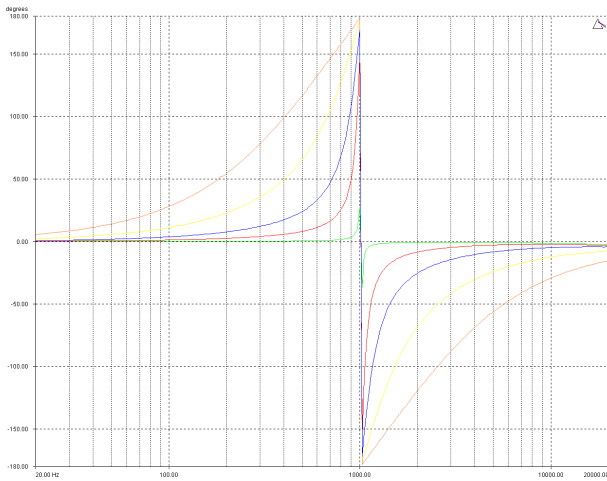

```
InA Input A APF:10
1K00Hz Q=30 Allpass
```

Remember – to change filter types, press **BYPASS** to bypass the filter, and then use **ENTER** to select the filter type.

The allpass filter has adjustable frequency and 'Q' (or Bandwidth) controls. These affect the frequency at which the phase effectively flips 180°, and the 'speed' at which this transition occurs.

The graph shows an allpass filter centred at 1kHz, with various 'Q' settings – the higher the 'Q' the faster the transition.

Phase Filter

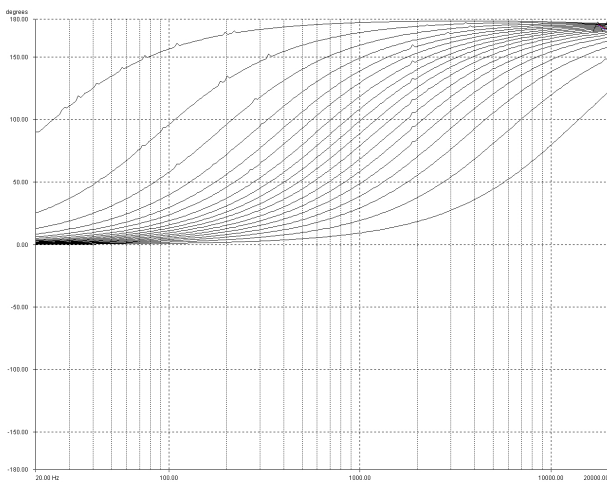

```
InA Input A PHS:10
1K00Hz 150° Phase
```

Remember – to change filter types, press **BYPASS** to bypass the filter, and then use **ENTER** to select the filter type.

The phase filter has adjustable frequency, and phase shift controls. This introduces a phase shift that gradually changes from 180° above the centre frequency to the specified value at the centre frequency, and tending towards 0° below the centre frequency.

This graph shows the phase shift relative to the input (ignoring processing delays), in 10° steps – the filter will actually provide higher resolution than this, operating in 2° steps. The filter is centred at 1kHz in this example.



Low/High Pass Variable 'Q' Filter (Low Pass shown)

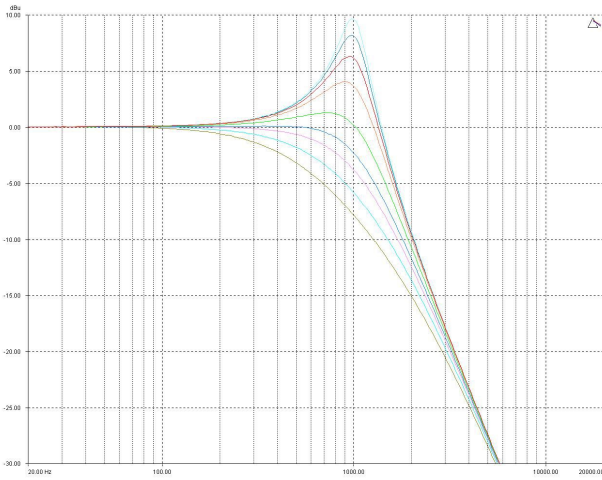

```
InA  Input A  LFF:1~\
1K00Hz Q=30 LFF VarQ
```

Remember – to change filter types, press **BYPASS** to bypass the filter, and then use **ENTER** to select the filter type.

The low and high pass variable 'Q' filters have adjustable frequency and 'Q' (or Bandwidth) controls. The 'Q' control adjust the damping of the filter, so that low 'Q' settings show less overshoot at the turnover frequency, but also slower roll-off.

Remember that 'Q' is 1/Bandwidth, so the higher the 'Q', the lower the Bandwidth, and the smaller the range of frequencies affected. The filter is primarily 12dB/Octave, but in achieving this sort of roll-off with a high 'Q' value will result in quite a

large overshoot in level at the turnover frequency. This type of filter is often also called a resonant filter.



Elliptical filters

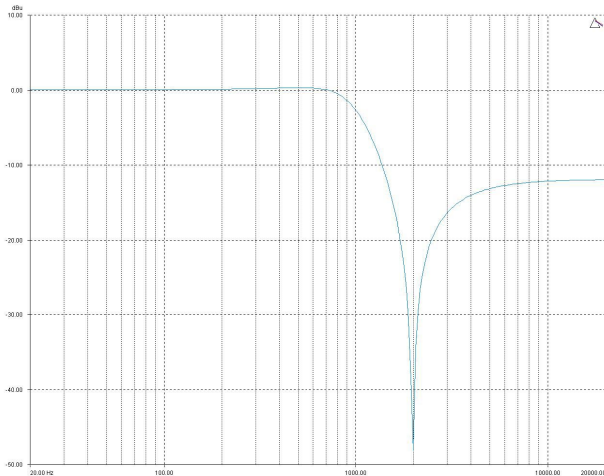

```
InA   Input A   HPF:1 ✓
1K00Hz   HP Ellip
```

Remember – to change filter types, press **BYPASS** to bypass the filter, and then use **ENTER** to select the filter type.

The elliptical filter has adjustable frequency only. This sets the 3dB point of the filter which features a steep roll-off (of approx 36dB/Octave down to one Octave above (or below in the case of a HPF) the turnover frequency).

However, the gain does increase again above this frequency to settle at 12dB down from 0dB. This filter can be used in conjunction with the standard crossover filters to produce sharper roll-offs than would be otherwise achievable.

The use of this filter is explained in the following example.

The graph shows three different low pass filter shapes. Number 1 is a standard 24dB/Octave Linkwitz-Riley curve. Number 2 is a 48dB/Octave Linkwitz-Riley.

As can be seen, number 2 is significantly steeper in roll-off than number 1, as would be expected.

However, number 3 is a 12dB/Octave Butterworth filter with an Elliptical Low Pass filter following it. This produces a combined roll-off very close to that of the 48dB/Octave (with the side effect of the response rising again after the initial drop from the pass band).

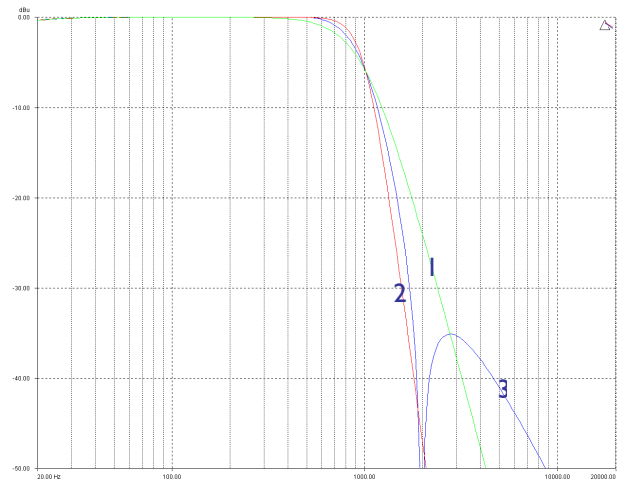

To produce a crossover filter of this shape it is simply a case of setting the low (or high) pass filter for that output to the desired crossover frequency, and selecting a 12dB Butterworth response:

```
OP1   Output 1   HPF ✓
250Hz   Butterworth 12dB
```

Then select a parametric section on the same output, and modify its behaviour (using the **ENTER** key) until the corresponding HPF Elliptical filter is selected. Set the turnover frequency of this filter to be the same as that of the crossover filter. Make sure you chose a high pass elliptical to work with a high pass crossover, and low pass elliptical to work with a low pass crossover.

```
InA   Input A   HPF:1 ✓
250Hz   HP Ellip
```



Specifications

Inputs: 2/4 electronically balanced ◆

Impedance: > 10k ohms.

CMRR : >65dB 50Hz - 10kHz.

Outputs: 4/6/8 electronically balanced ◆

Source Imp: < 60ohms

Min. Load: 600ohm

Max. Level: +20dBm into 600 ohm

Frequency Resp.: ±1/2dB 20Hz-20kHz
-3dB @ 32kHz

Dyn. Range: > 116dB 20Hz-20k unwt'd

Distortion: < .02% @ 1kHz, +18dBm

Maximum Delay: 650 mS

Min Step Size: 0.3 μS

Input Gain: +6dB to -40dB in 0.1dB steps

Output Gain: +15dB to -40dB in 0.1dB steps and mute

Parametric Equalisation

8 per Input / 9 Sections per Output

Filter Gain: +15dB to -30dB in 0.1dB steps.

Freq. Range: 19.7Hz - 32kHz, 1/36 octave steps.

Filter Q / BW: 0.4 to 128 / 2.5 to 0.008

(Sections switched to shelving response)

Low frequency: 19.2Hz - 1kHz

High frequency: 1kHz - 32kHz

Shelf gains: ±15dB in 0.1dB steps.

High and Lowpass Filters

Filters: 1 of each per output.

Freq. Range HPF: 10Hz - 16kHz

1/36 octave steps.

Freq. Range LPF: 35Hz - 22kHz

1/36 octave steps.

Responses:

1st Order 6dB/Oct.

Bessel/Butterworth/Linkwitz-Riley 12-24-48dB/Oct.

Bessel/Butterworth 18dB/Oct.

Limiters

Program Limiter:

Threshold: +22dBu to -10dBu

Attack time: 0.3 to 90 milliseconds

Release time: 2/4/8/16/32 x Attack time

“D-Max” Limiter:

Attack Time: -60uS

Release Time: Slow/Medium/Fast

Display: 2 x 24 Character LCD

Input meter: 2 x 6 point, -24dB to digital clip.

Output meter: 8 x 6 point, -24dB to +4dB into limit.

Connectors

Inputs: 3 pin female XLR

Outputs: 3 pin male XLR.

External: 9 pin DEE connector (RS232)

RS485: 3 pin male XLR (out) 3 pin male XLR (in)

Power: 3 pin IEC

Power: 60 to 250V ±15% @ 50/60Hz.

Consumption: < 30 watts.

Weight: 3.3kg. Net (4.7kg. Shipping)

Size: 1.75"(1U) x 19" x 11.8"

(44 x 482 x 300mm) excluding connectors

◆ Transformer options available

Due to continuing product improvement the above specifications are subject to change.

Latency: 1.5mS (analogue in – analogue out @ 96kHz)



Warranty

This product is warranted against defects in components and workmanship only, for a period of five years from the date of shipment to the end user. During the warranty period, XTA will, at its discretion, either repair or replace products that prove to be defective, provided that the product is returned, shipping prepaid, to an authorised XTA service facility. Defects caused by unauthorised modifications, misuse, negligence, act of God or accident, or any use of this product that is not in accordance with the instructions provided by XTA, are not covered by this warranty. This warranty is exclusive and no other warranty is expressed or implied. XTA is not liable for consequential damages.



Options and Accessories

Part Number	Part Description
ITX-428	Transformer balanced inputs (factory fitted only)
OTX-428	Transformer balanced outputs (factory fitted only)
OPT-PCI	'Type I' 512k SRAM PCMCIA card
INT-485	RS232 to RS485 converter kit with 9 pin 'D' type to XLR male adaptor cable (from PC to DP428)
USB-485	USB-Serial-RS485 converter with special K2-ADE RS232-485 Converter

XTA has a range of tried and tested interfaces, including USB and wireless solutions, all of which are listed in the XTA Interface Guide, available from our website. We can supply all the interfaces described in this guide directly – please get in touch.



Index

A

Accessories · 51
AES Diagnostics · 32
AES Interface · 31
AES Menu · 23
All Pass · 47
Attack Times · 39

B

Bandpass · 46
Base Delay · 16

C

Clip Limiter · 19, 40
Cloning · 36
Cold Reboot · 36
Compact Flash · 35
Crossover Menu · 23

D

Delay · 16
 Look Ahead · 40
Digital In & Out · 31
D-Max · 40

E

Editing
 Base Delay · 16
 Graphic EQ · 16
 High Pass Filter · 18
 Input Gain · 16
 Limiters · 19
 Low Pass Filter · 18
 Output Delay · 17
 Output Gain · 17
 Parametric EQ · 16, 18
 Polarity · 17
Elliptical Filter · 49

F

Features · 8
Flat Topped EQ · 45
Free Assign · 15
Front Panel · 9

G

Ganging Inputs · 20
Ganging Outputs · 20
Global Memory Menu · 23
GQ600 · 37
Graphic EQ · 16, 37
Graphic Menu · 23

H

High Pass Filter · 18

I

Input Gain · 16
Input Section Menu · 23
Interface
 RS232 · 26
 RS485 · 29
 USB · 26
Interface Menu · 23

L

Limiter
 Overshoot Prevention · 41
Limiter Threshold · 42
Limiters · 39
Load New Software · 27
Lockouts · 33
Look Ahead · 40
Look Ahead Delay · 40
Low Pass Filter · 18

M

Master Password · 34
Memory Cards · 35
Memory Structure · 24
Menus
 Details · 23
 Quick Ref. · 21
 Shortcuts · 22
Midi Start/Stop · 30

N

Notch · 46
NTH Response · 49



O

Options · 51
Output Delay · 17
Output Gain · 17

P

Parametric EQ · 16, 18
Password Override · 34
Passwords · 33
PCMCIA Card · 35
Phase · 47
Polarity · 17, 47
Preset Updates · 35
Program Limiter · 19

Q

Quick Setup · 11

R

Rear Panel · 10
Release Times · 39
Resonant Filter · 48
Routing · 15
 Basic · 12
 Free Assign · 15
 Presets · 12
RS232 Interface · 26
RS485 Interface · 29

S

Security · 33
Security Menu · 23
Shadow IDs · 28
Shelving EQ · 45
Shipping · 7
Sidechain
 Delay · 40
Software Updates · 35
Special · 38
Specifications · 50
Standard Parametric · 44
Start-up · 11
System Menu · 23

U

Unit Cloning · 36
Unlocking · 34
Unpacking · 7
Updating Software · 27
Upgrading · 27
USB Interface · 26

V

Vari-Q · 48

W

Waranty · 51



Appendix I – DP446 Default Crossover Configurations

2 x 3 Way

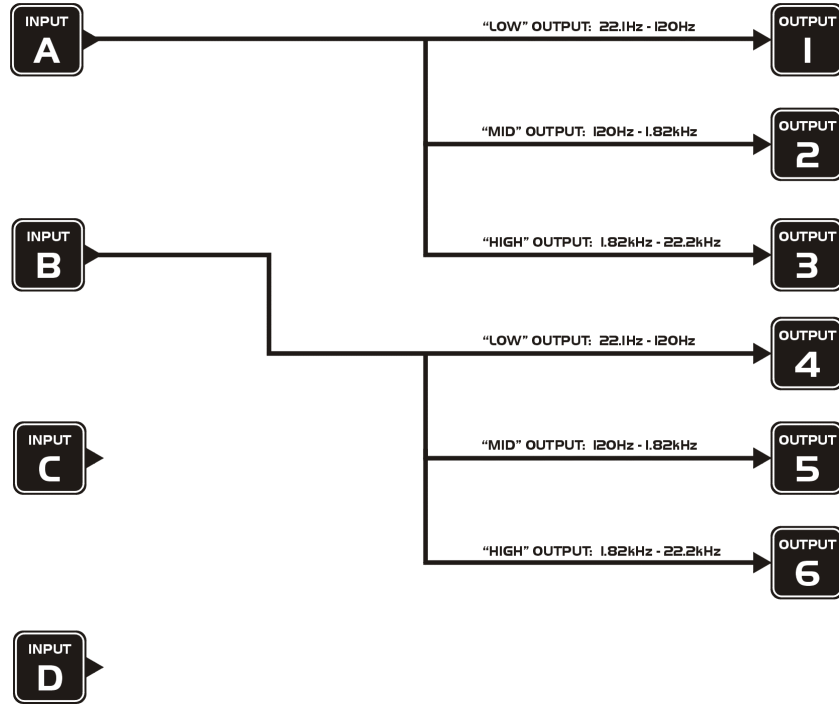

3 x 2 way

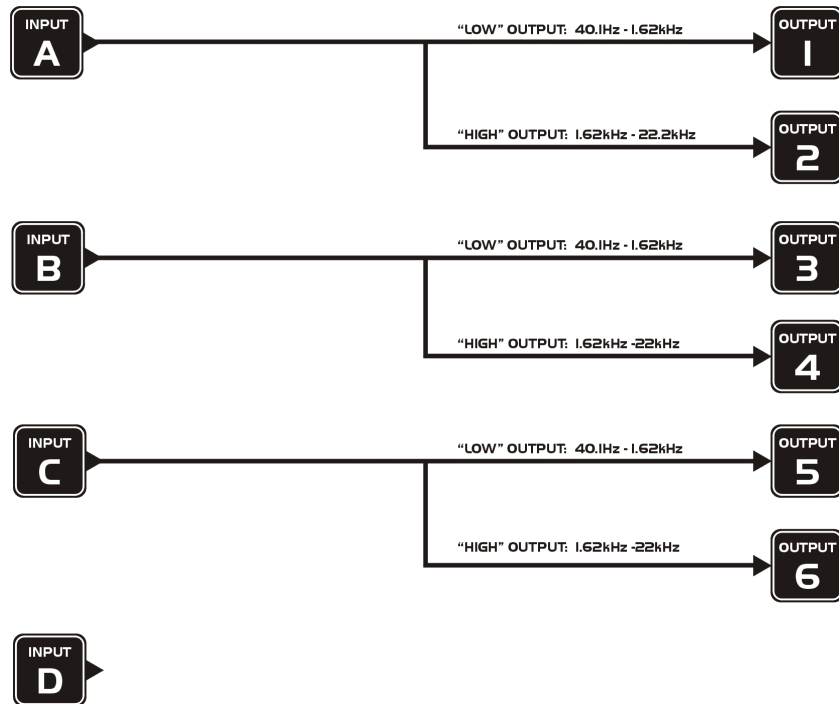

2 x 2 Way + 2 Aux

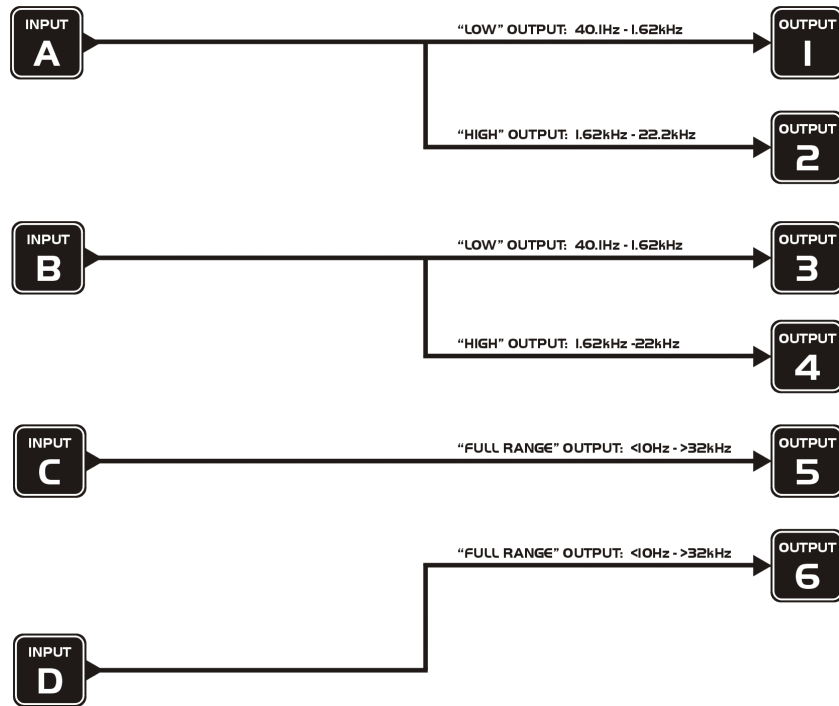

1 x 6 way

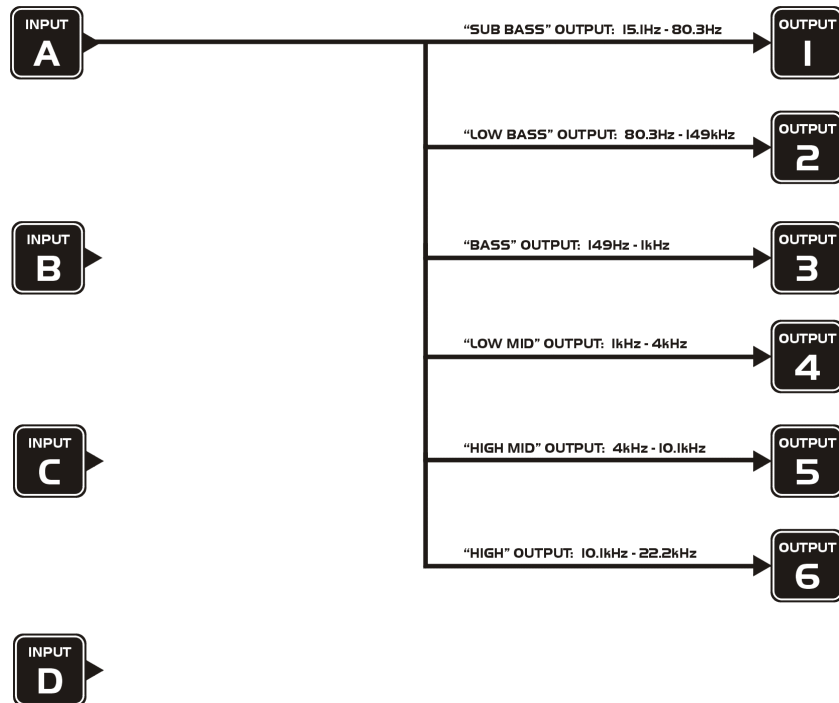

Appendix II – DP444 Default Crossover Configurations

2 x 2 Way

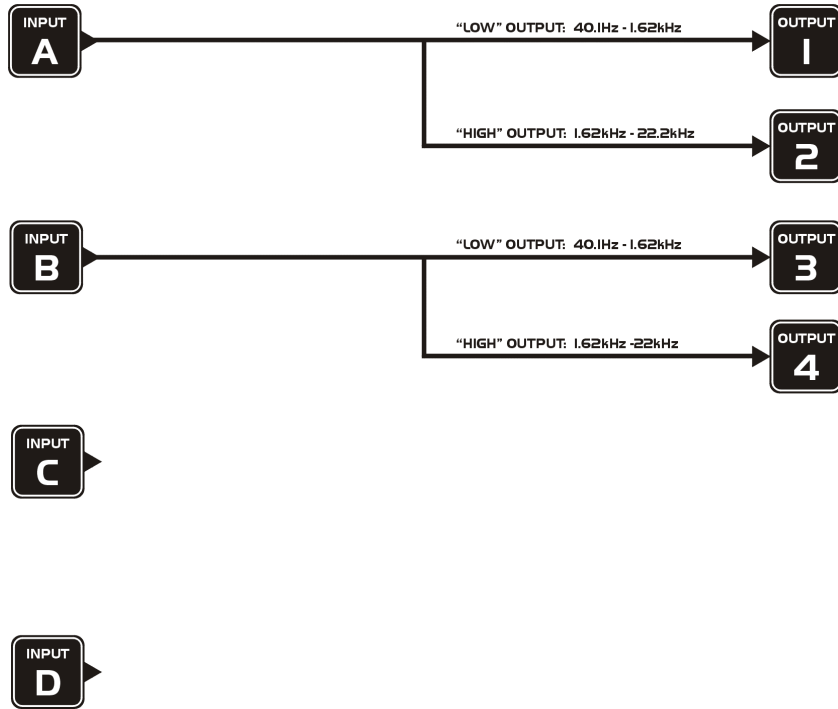

1 x 4 way

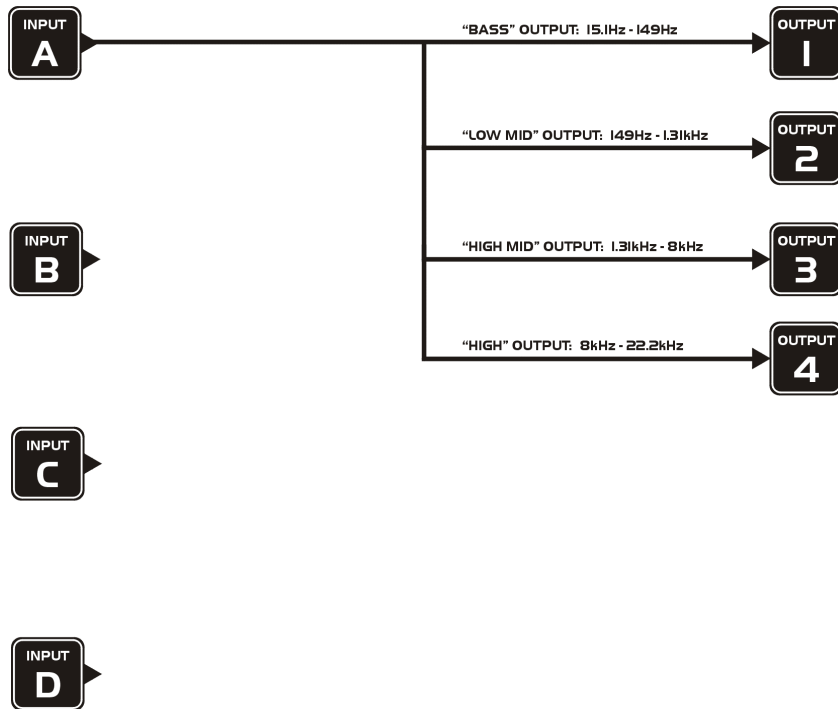

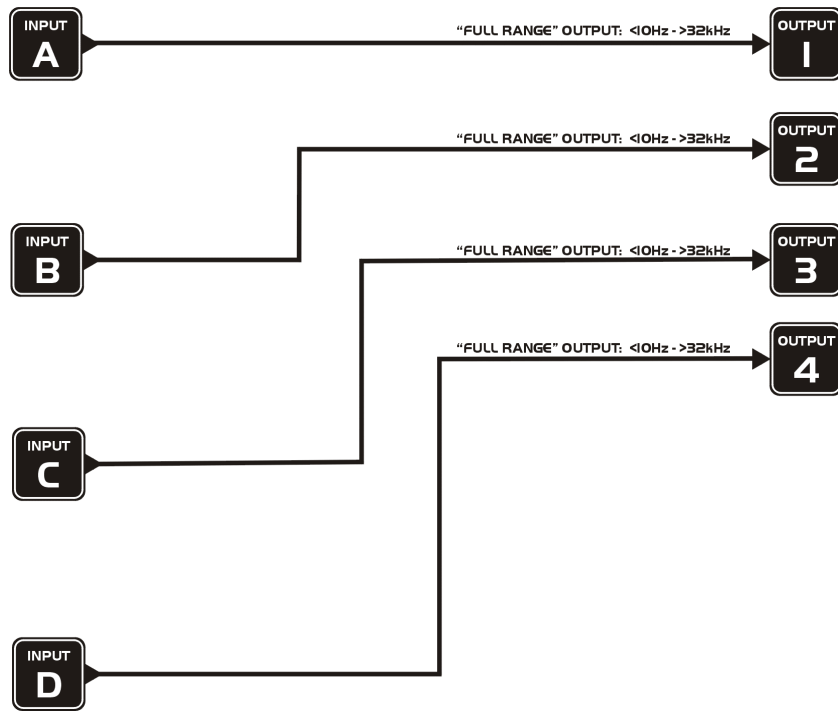

Appendix III – DP424 Default Crossover Configurations

2 x 2 Way

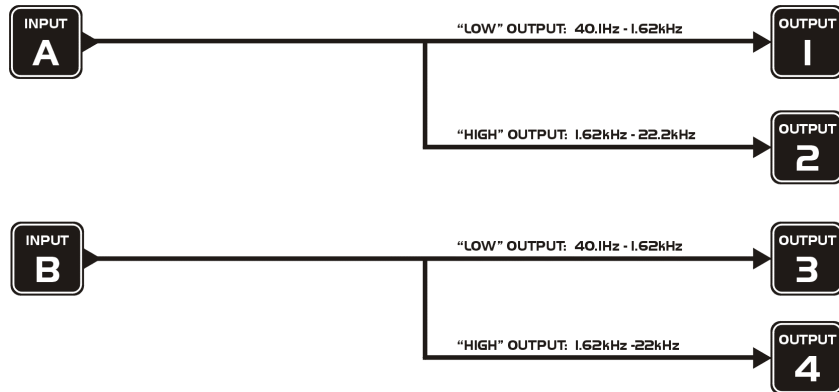

1 x 4 way

