



15.6"

User Manual
VER 1.0

Model NO.:

PVS0615

Portable all in one Multi-format Video Switcher

USING THE UNIT SAFELY

Before using this unit, please read below warning and precautions which provide important information concerning the proper operation of the unit. Besides, to assure that you have gained a good grasp of every feature of your new unit, read below manual of PVS0615 video switcher. This manual should be saved and kept on hand for further convenient reference.



Warning And Cautions

- ※ To avoid falling or damage, please do not place this unit on an unstable cart, stand, or table.
- ※ Operate unit only on the specified supply voltage.
- ※ Disconnect power cord by connector only. Do not pull on cable portion.
- ※ Do not place or drop heavy or sharp-edged objects on power cord. A damaged cord can cause fire or electrical shock hazards. Regularly check power cord for excessive wear or damage to avoid possible fire / electrical hazards.
- ※ Ensure unit is properly grounded at all times to prevent electrical shock hazard.
- ※ Do not operate unit in hazardous or potentially explosive atmospheres. Doing so could result in fire, explosion, or other dangerous results.
- ※ Do not use this unit in or near water.
- ※ Do not allow liquids, metal pieces, or other foreign materials to enter the unit.
- ※ Handle with care to avoid shocks in transit. Shocks may cause malfunction. When you need to transport the unit, use the original packing materials or alternate adequate packing.
- ※ Do not remove covers, panels, casing, or access circuitry with power applied to the unit! Turn power off and disconnect power cord prior to removal. Internal servicing / adjustment of unit should only be performed by qualified personnel.
- ※ Turn off the unit if an abnormality or malfunction occurs. Disconnect everything before moving the unit.

Note: due to constant effort to improve products and product features, specifications may change without notice.

CONTENT

1. Brief Introduction.....	1
1.1 Overview.....	1
1.2 Main Features.....	1
2. Connections.....	2
2.1 Interfaces.....	2
2.2 Specification.....	3
3. Control Panel.....	5
3.1 Description.....	5
3.2 Keyboard Button.....	6
4. Operation Instruction.....	9
4.1 Multiview Output Layout.....	9
4.2 T-Bar Calibration.....	9
4.3 PGM PVW Switching.....	10
4.3.1 PGM, PVW Channel Selection.....	10
4.3.2 Tally Output.....	11
4.3.3 Transition Control.....	12
4.3.4 FTB (Fade to Black).....	12
4.3.5 Source Selection of Channel 5 and Channel 6.....	12
4.3.6 USB Media Player.....	12
4.4 SDI PGM/AUX and Multiview Output Format.....	13
4.5 Audio Mixer Setting.....	14
4.5.1 Audio Description.....	14
4.5.2 Audio Mode.....	14
4.6 Transition Effects.....	15
4.6.1 MIX Transition.....	15
4.6.2 WIPE Transition.....	15
4.6.3 FADE Transition.....	15
4.6.4 PIP and POP.....	16
4.6.5 Luma Key.....	16
4.6.6 Chroma Key.....	17
4.7 Video Record.....	18
4.7.1 Basic Specification.....	18
4.7.2 SD Card Install and Uninstall.....	18
4.7.3 Recording Control.....	18
4.7.4 Recording Settings.....	19
5. Main Menu Setting.....	19
5.1 System Settings.....	20
5.1.1 Language.....	20
5.1.2 Clock.....	20
5.1.3 Clock Time Setting.....	20
5.2 Network Settings.....	20
5.2.1 Network.....	20
5.2.2 NetMask.....	21
5.2.3 GateWay.....	21
5.3 Record Settings.....	21

1. Brief Introduction

1.1 Overview

PVS0615 is an all-in-one 6-channel video switcher that allows video switching, audio mixing, and video recording. The unit integrated a 15.6" LCD monitor which can be used in wide variety of venues for events, seminars, etc.



1.2 Main Features

- Portable All-In-One design with 15.6 inch FHD LCD display
- 6 channel inputs: 4 × SDI and 2 × DVI-I/HDMI/VGA/USB player inputs
- 3 × SDI & 2 × HDMI PGM outputs, 1 × HDMI multiview output
- SDI output 3 is AUX output, can be selected as PGM or PVW
- Input format auto-detected and PGM outputs select-able
- Luma Key, Chroma Key for virtual studio
- T-Bar/AUTO/CUT transitions
- Mix/ Fade/ Wipe transition effects
- PIP & POP mode size and position adjustable
- Audio mixing: TRS audio, SDI audio and USB media audio
- Support record by SD card, up to 1080p60

2. Connections

2.1 Interfaces



1	12V / 5A DC Power In
2	TRS Balanced Analog Audio Out
3	TRS Balanced Analog Audio In
4	2×HDMI Out (PGM)
5	3×SDI Out (PGM), SDI Out 3 can be for AUX output
6	4×SDI In
7	2×HDMI / DVI-I In
8	2×USB Input (Media player)
9	HDMI Out (Multiviewer)
10	GPIO (Reserve for Tally)
11	SD Card Slot
12	RJ45 (For Sync Time & firmware upgrade)
13	Earphone Out

2.2 Specification

LCD Display	Size	15.6 inch
	Resolution	1920×1080
Inputs	Video Inputs	SDI×4, HDMI/DVI/VGA/USB×2
	Bit Rate	270Mbps~3Gbps
	Return Loss	>15dB, 5MHz~3GHz
	Signal Amplitude	800mV±10% (SDI/HDMI/DVI/VGA)
	Impedance	75Ω (SDI/VGA), 100Ω (HDMI/DVI)
	SDI Input Format	1080p 60/59.94/50/30/29.97/25/24/23.98 1080psF 30/29.97/25/24/23.98 1080i 60/59.94/50 720p 60/59.94/50/30/29.97/25/24/23.98 625i 50 PAL, 525i 59.94 NTSC
	HDMI Input Format	4K 60/50/30, 2K 60/50/30 1080p 60/59.94/50/30/29.97/25/24/23.98/23.976 1080i 50/59.94/60 720p 60/59.94/50/30/29.97/25/24/23.98 576i 50, 576p 50
	VGA/DVI Input Format	1920×1080 60Hz/ 1680×1050 60Hz/ 1600×1200 60Hz/ 1600×900 60Hz/ 1440×900 60Hz/ 1366×768 60Hz/ 1360×768 60Hz/ 1280×1024 60Hz/ 1280×960 60Hz/ 1280×800 60Hz/ 1280×768 60Hz/ 1280×720 60Hz/ 1152×864 60Hz/ 1024×768 60Hz/ 640×480 60Hz
	SDI Video Rate	Auto detection, SD/HD/3G-SDI
	SDI Compliance	SMPTE 259M/ SMPTE 292M/ SMPTE 424M
Bit Rate	270Mbps~3Gbps	

	Color Space and Precision	SDI: YUV 4:2:2, 10-bit; HDMI: RGB 444 8/10/12bit; YUV 444 8/10/12bit; YUV 422 8/10/12bit
Outputs	PGM Outputs	3×HD/3G-SDI; 2×HDMI Type A
	PGM Output Format	1080p 50/60/30/25/24 1080i 50/60
	Multiview Output	1×HDMI Type A
	Multiview Output Format	1080p 60
	Return Loss	>15dB 5MHz~3GHz
	Signal Amplitude	800mV±10% (SDI/HDMI/DVI/VGA)
	Impedance	SDI: 75Ω; HDMI: 100Ω
	DC Offset	0V±0.5V
Audio	Audio Input	1×TRS(L/R), 50 Ω
	Audio Output	1×TRS(L/R), 50 Ω; 3.5mm Earphone×1, 100 Ω
Others	LAN	RJ45
	SD Card Slot	1
	Power	DC 12V, 2.75A
	Consumption	<33W
	Operation Temperature	-20℃~60℃
	Storage Temperature	-30℃~70℃
	Operation Humidity	20%~70%RH
	Storage Humidity	0%~90%RH
	Dimension	375×271.5×43.7mm
	Weight	3.8Kg
	Warranty	2 Year Limited
Accessories	Accessories	1×Power Supply (DC12V 5A), 1×User Manual

3. Control Panel

3.1 Description

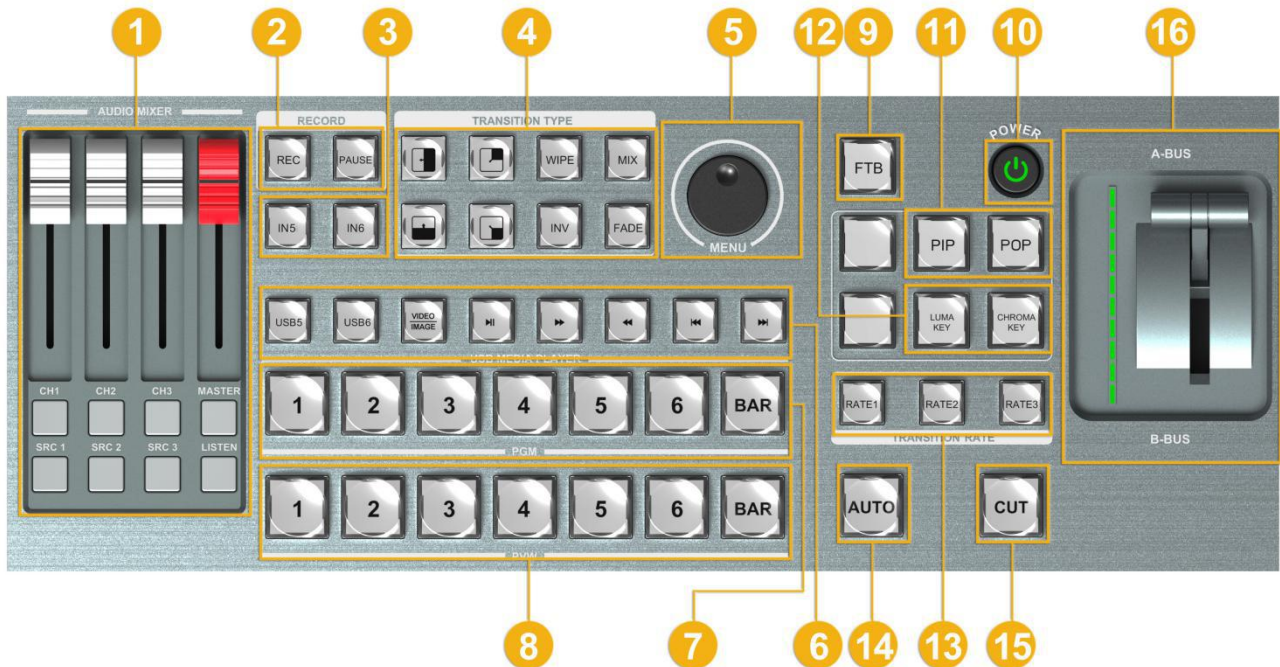

1	Audio Mixer Control	9	FTB
2	Record Control	10	Power Switch
3	Video Source of Channel 5 and Channel 6	11	PIP, POP
4	MIX, WIPE, FADE, Inverse Transition Effect	12	Luma Key, Chroma Key
5	Menu Control	13	Transition Speed
6	USB Media Control	14	AUTO
7	Program Row	15	CUT
8	Preview Row	16	T-bar Manual Transition

3.2 Keyboard Button

■ **Audio Mixer**

Press CH1/ CH2/ CH3 button to select the channel for audio mixing.

Press SRC 1/SRC 2/SRC 3 button to select the audio source Master for adjust the main mixing audio to Program.

The faders are for adjusting the audio volume.

LISTEN button for earphone source selection.



■ **Record Control**

Press REC button to start the video recording.

Press REC button again to stop recording.

Press PAUSE button to pause the recording process and press it again to continue.



■ **Video Source of Channel 5 and Channel 6**

Press IN5 to switch the video source of Channel 5 between HDMI 5/DVI 5/VGA 5/ USB 5.

Press IN6 to switch the video source of Channel 6 between HDMI 6/ DVI 6/ VGA 6/ USB 6.



■ **Transition Effects**

3 transition effects: MIX, WIPE and FADE.

WIPE starts from different direction. INV button for alternating the direction inverted.

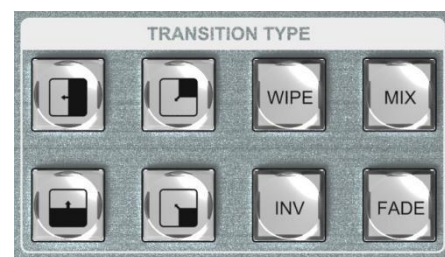

■ **Menu Control**

Rotate the knob clockwise or counterclockwise to adjust the menu and increase and decrease the value. Press the knob to select a menu option.

Menu content show on the menu zone from lower right corner of the LCD screen.

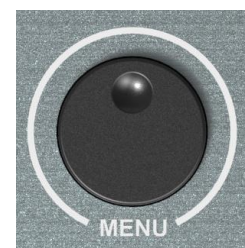

■ **USB Media Player Control**

Press USB 5/ USB 6 button to select the one which you want to manage.

VIDEO/IMAGE buttons is for switching the media format between video and image. The default setting is video.

There are Play/Pause, Fast Forward, Fast Backward, BACK and NEXT buttons for USB media control.

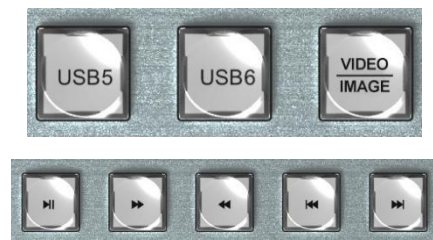

■ **PGM and PVW**

PGM row is for selecting the signal source for Program. Selected PGM button will turn on to red LED.

PVW row is for selecting the signal source for Preview. Selected PVW button will turn on to green LED.

BAR button is for immediate switching the signal source of Program and Preview to color bar.



■ **FTB**

FTB, Fade to black. Press this button it will fade the current video Program source to black. The button will flash to indicate that it's active.

When press the button again it acts in reverse from complete black to the currently selected Program video source, and button stop flashing.



■ **Power**

Press the POWER button to turn on the device.
Long press POWER button 3s to turn off the device.



■ **PIP and POP**

PIP, Picture in Picture. The Program is display on the full screen, at same time the Preview source will be displayed in the Program window as an inset window. The size and position of the inset window can be adjusted from the menu.

POP, Picture outside Picture. This is the same function as PIP only this allows you to see the Program source and Preview source side by side.



■ **Luma Key**

Luma Key consists of one video source containing the video image that will be stacked on top of the background.

All of the black areas defined by the luminance in the video signal will be made transparent so that the background can be revealed underneath.

So, the final composition does not retain any black from the graphic because all of the black parts have been cut out of the image.

■ **Chroma Key**

In a Chroma Key two images are combined using a special technique and a color from one image is removed, revealing another image behind it. Chroma Key is commonly used for weather broadcasts, where the meteorologist appears to be standing in front of a large map. In the studio the presenter is actually standing in front of a blue or green background. This technique is also referred to as color keying, color-separation overlay, green screen, or blue screen.



■ **CUT and AUTO**

CUT performs a simple immediate switch between Program and Preview. The selected transition WIPE, MIX or FADE is not used.

AUTO performs an automated switch between Program and Preview. The selected transition WIPE, MIX or FADE will also be used.

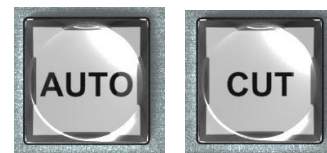

■ **Transition Rate**

3 transition speed rates for selection under the AUTO transition mode.



■ **T-Bar Manual Transition System**

User can do the transition from the current Program source to the selected Preview source. The selected transition effects will work meantime.

When the T-Bar has travelled from B-BUS to A-BUS the transition between sources is complete. The T-Bar has indicators next to it which light when the transition is complete.



4. Operation Instruction

4.1 Multiview Output Layout

1) PGM and PVW as Preview and Program displayed as following image. The level meter of PGM audio is shown only in multiview. SDI/HDMI PGM out is without any overlays.



2) The following 6 windows come from the 6 input signals. The signal source of window 5 and 6 can be selected from HDMI, DVI, VGA, USB.



3) The lower right corner displays the menu and status information. The CH1, CH2, CH3 are the channel selection of the 3 audio sources for audio mixer. There is a real-time Digital clock/ Analog clock displayed beside the menu.

4.2 T-Bar Calibration

The T-Bar of the video switcher may happen to misalignment, when the origin of the coordinates offset the T-Bar calibration is necessary before using.

1) Power off the video switcher and press button 1 and 2 of PVW at same time. **KEEP** pressing the buttons until all calibration process finish.



2) Turn on the video switcher, then the LED indicators will be turn on from bottom to top.

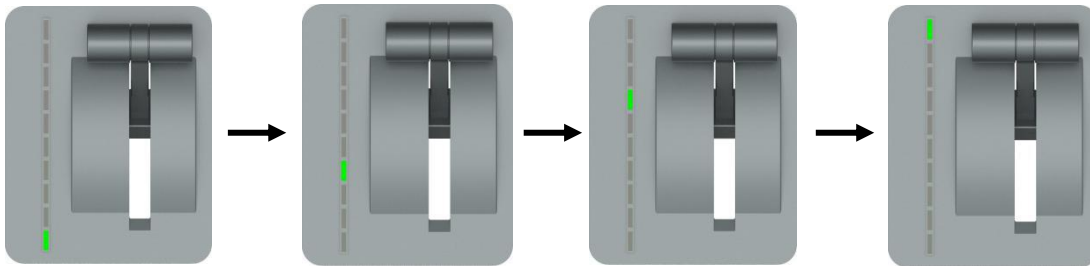

3) Adjust the T-Bar to A-BUS or B-BUS until all LED indicators turn on. Below image is an example of the LED indicators status when switching the T-Bar from B-BUS to A-BUS.

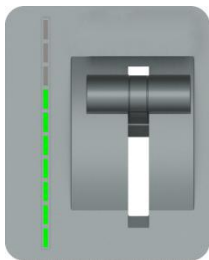

4) Then the T-Bar calibration is finished, and you can release the button 1 and 2.

4.3 PGM PVW Switching

4.3.1 PGM, PVW Channel Selection

Below 1-6 buttons from PGM and PVW are corresponding with the 6 windows in the below of the multiview layout. The selected button from PGM turns on to red LED, and the selected button from PVW turns on to green LED.

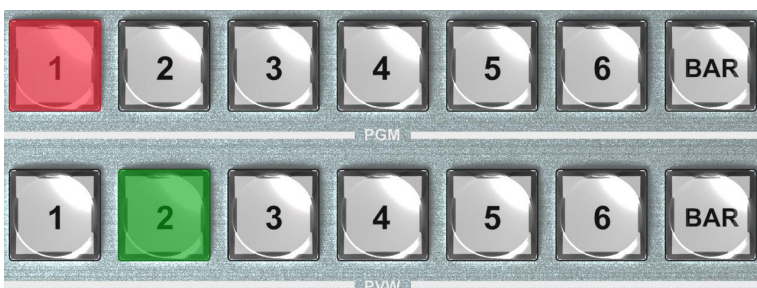

The selected PGM source will circled in red border, while the selected PVW source will be circled in green border.

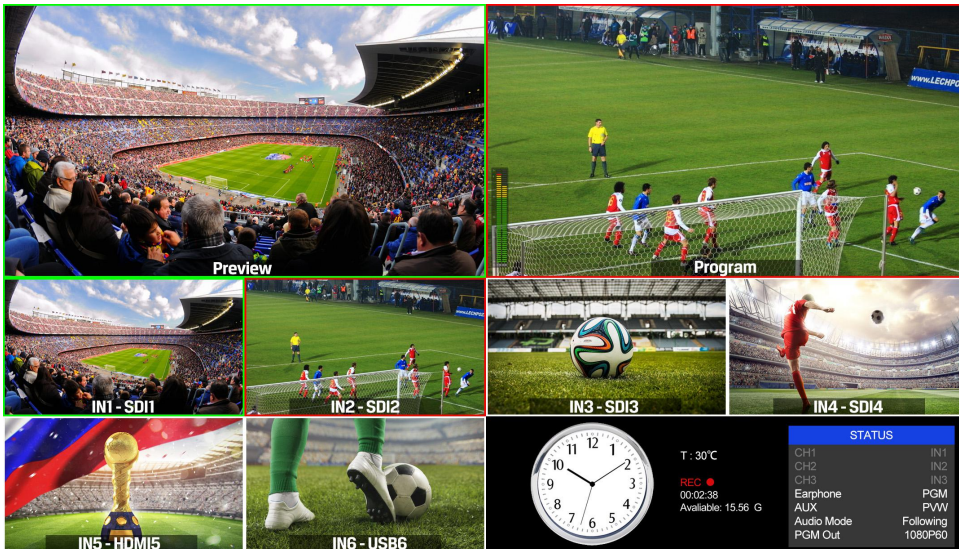

For example, switching the PGM source to SDI 1 and PVW source to SDI 2. The button selection as below.

The default sources of PVW and PGM are SDI 1 and SDI 2 when the first turn the video switch on. When operating the AUTO or T-Bar transition, the selection from PGM row and PVW row is invalid, both of the LED will turn red.



4.3.2 Tally Output

PVS0615 is equipped with a 25-pin GPIO interface for tally, the pin outputs are defined as follows:

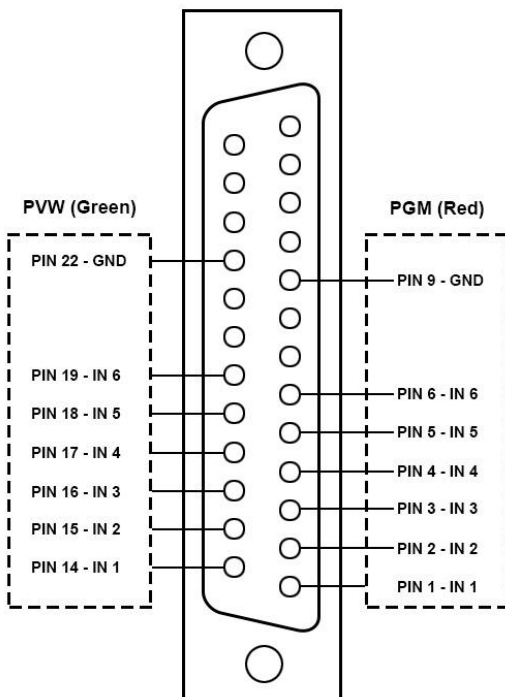

Note:

1. When video channel is PVW or PGM, GPIO output is at low level.
2. The PIN not defined here is reserved, with no function now.

4.3.3 Transition Control

There are two transition control types for this video switcher: Transition without effects and Transition with effects.

1) Transition without Effects



CUT performs a simple immediate switch between Preview and Program views. This is no delay seamless switching and the selected transition effect WIPE, MIX or FADE is not used.

2) Transition with Effects



AUTO performs an automated switch between Preview and Program views. The timing of the transition is set by the chosen speed button. The selected transition WIPE, MIX or FADE will also be used.

T-Bar manual transition performs similar to AUTO, but it is more flexible that the timing of the transition depends on the speed of the manual switch.

4.3.4 FTB (Fade to Black)



Press FTB button it will fade the current video Program source to black. The button will flash to indicate that it's active. When press the button again it acts in reverse from complete black to the currently selected Program video source, and button stop flashing. FTB is usually used for emergency condition.



Note: When the PGM window display black and keep black even after transition, please check if the FTB button flashing. Press the button again when it is flashing to stop black.

4.3.5 Source Selection of Channel 5 and Channel 6

Press the button IN5/ IN6 to cyclic switch the video source between HDMI, DVI, VGA and USB. The default format is HDMI. The switcher will save your last format choice when power on again.

4.3.6 USB Media Player

1) USB Media Player Setup

Plug in the USB disk input the USB port in the side panel as below image:



Setup the video source of channel 5 or 6 to USB as point 4.3.4, then manage the USB media play from the control panel.

Press USB5 or USB6 button to select the one which you want to manage. The VIDEO/IMAGE button is for switching the media format between video and picture. The default setting is video format when the video switcher power on.

There are Play/Pause, Fast Forward, Fast Backward, NEXT and BACK buttons to control the media source from USB. The Fast Forward and Fast Backward support max 32 times speed to play the video.



2) Video Format Supporting

FLV	MPEG4(Divx), AVC(H264), FLV1	MP4	MPEG4(Divx), MPEG4(Xvid), AVC(H264), HEVC(H265)
AVI	MPEG4(Divx), MPEG4(Xvid), AVC(H264), HEVC(H265), MPEG2	MKV	MPEG4(Divx), MPEG4(Xvid), AVC(H264), HEVC(H265)
MPG	MPEG1	MOV	MPEG4(Divx), AVC(H264), HEVC(H265)

3) Image format support: BMP, JPEG, PNG.

4.4 SDI PGM/AUX and Multiview Output Format

The output format of multiview is fixed at 1080p60, and for PGM output can be set by the knob. Except PVW and PGM output, there is a AUX for choice in PGM SDI 3, you can quickly select the auxiliary output between PVW and PGM via Menu knob. It is default as PGM after reset. There are resolution 1080P50/60/30/25/24Hz, 1080I 50/60Hz selectable for SDI/HDMI PGM and AUX outputs.

STATUS	
CH1	IN1
CH2	IN2
CH3	IN3
Earphone	PGM
AUX	PGM
Audio Mode	Following
PGM Out	1080P60

STATUS	
CH1	IN1
CH2	IN2
CH3	IN3
Earphone	PGM
AUX	PVW
Audio Mode	Following
PGM Out	1080P60

4.5 Audio Mixer Setting

4.5.1 Audio Description

This video switcher is coming with 1 channel L/R analog audio input & output and SDI embedded audio.



4.5.2 Audio Mode

1) Mixing Mode

Rotary and press the knob button  to set audio mode as mixing.

Press CH1/CH2/CH3 button to enable the mixing audio mode, total 3 channels for mixing.

Press SRC 1/ SRC 2/ SRC 3 buttons to select the audio source from SDI1/ SDI2/ SDI3/ SDI4/ IN5 / IN6/ TRS IN.

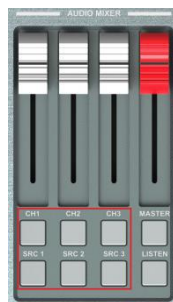
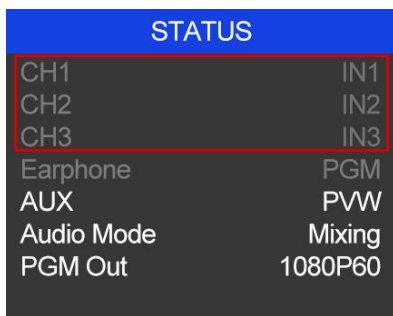

2) Following Mode

after that the video switcher will remember your last choice. Press Master button to enable the following mode audio control. When the audio is in Following mode the audio is coming from the embedded audio of Program video source. Adjust the master fader to control the audio volume.

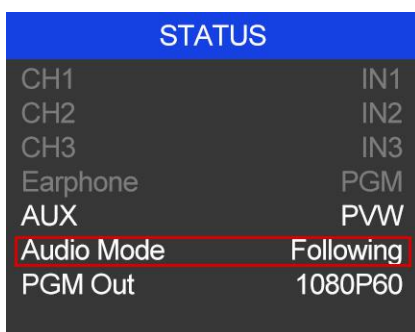

2) Earphone

Press LISTEN button and use a 3.5mm earphone to monitor an assigned audio, PGM audio as the default. Press LISTEN button cyclically to assign one channel audio as the audio source.

STATUS	
CH1	IN1
CH2	IN2
CH3	IN3
Earphone	PGM
AUX	PVW
Audio Mode	Mixing
PGM Out	1080P60



4.6 Transition Effects

4.6.1 MIX Transition



Pressing the MIX button selects a basic A/B Dissolve for the next transition. When button LED turns on it is active. Then use T-Bar or AUTO to operate the transition. The MIX transition effect as below



WIPE is a transition from one source to another and is achieved by replacing the current source by



another source. Press the WIPE button and the LED turns on then it is active. There are total 9

WIPE selections wiping start from different directions. Such as if choosing , then use T-Bar or AUTO to operate the transition, the WIPE effect as following:



INV button is an alternative button. Press it first and then press a Direction button, the WIPE will start from an inverse direction.

4.6.3 FADE Transition

Fade is a transition from one source to another with fade gradually transition effect. Press the FADE



button and use T-Bar or AUTO to operate the FADE transition.

4.6.4 PIP and POP

When the T-Bar located at B-BUS to active the PIP/POP, there will be a small image display on the top left corner of the PVW window as following image:



Press button 1-6 from PVW row to switch the video source of PIP/POP.

When press PIP/POP button the menu will enter into an interface as below image. The window size, position and border of PIP can be set from menu by the knob.

PIP	
Window	1
H Position	0
V Position	0
Size	Small
Border Enable	On
Border Width	2
Border Color	White
Exit	

POP	
Window	1
H Position	0
V Position	270
Size	Small
Border Enable	On
Border Width	2
Border Color	White
Exit	

4.6.5 Luma Key

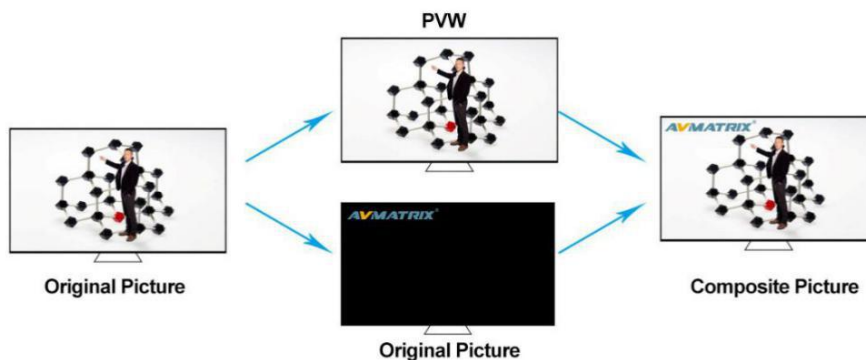

When turn on the Luma Key, all of the black areas defined by the luminance in the video signal will be made transparent so that the background can be revealed underneath. Therefore, the final composition does not retain any black from the graphic because all of the black parts have been cut out of the image. This function is often used for subtitle overlay of virtual studio.

1) Switching a video with black background and white font subtitle to PVW and turn on the Luma Key. Then enter into the Key menu to configure the value of Luma Key. Using CUT, AUTO, or T-Bar to switch the subtitle to overlay in the PGM window.

2) When you press Luma key button, indicator turns on and menu enter into the key setting interface as below image. The color gamut of the Luma Key can be set from the menu by the knob.

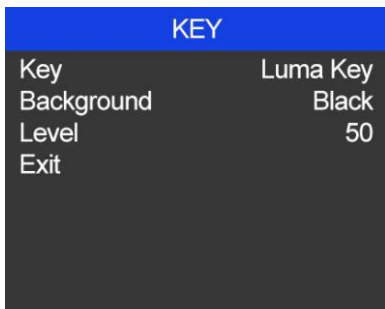

4.6.6 Chroma Key

Turn on the Chroma Key, a color from the key source will be removed, revealing another background image behind it. Chroma Key is usually used for virtual studio, such as weather broadcasts, where the meteorologist appears to be standing in front of a large map. In the studio the presenter is actually standing in front of a blue or green background.

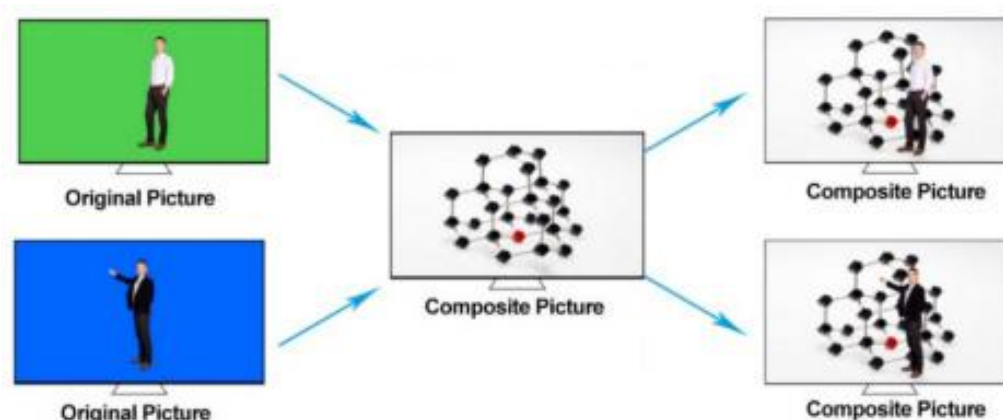

1) Switching a video with blue or green background to PVW window, and turn on the Chroma Key. Then enter into the Key menu to configure the value of Chroma Key. Using CUT, AUTO, or T-Bar to switch the image to overlay in the PGM window.

2) When you press Chroma Key button, indicator turns on and menu enter into the key setting interface as below image. The KEY background can be switch between Green and Blue. The color gamut of the Chroma Key can be set from the menu by the knob.

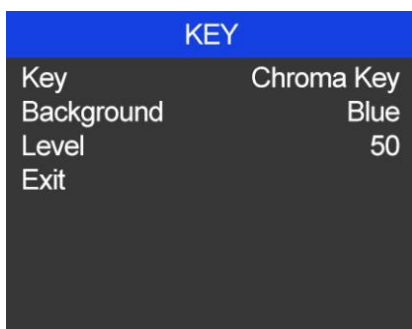

4.7 Video Record

4.7.1 Basic Specification

Record Video Source	PGM
Record Storage	SD Card (class 10)
SD Card Format	Max 64GB (file system format exFAT/ FAT32)
Record Video Format	H.264 (mp4)
Record Video Resolution	1080p 60/50/30/25/24hz, 1080i 60/50hz

4.7.2 SD Card Install and Uninstall

1) Install SD card:

First, format SD card to exFAT/ FAT32 file system format. Install Plug and press the SD card into the slot from the side of video switcher. Wait 3 sec, the LED indicator beside it will turn on.

2) Uninstall SD card:



Press the card to take it out. Use a card reader to play or copy the video files in a computer.

4.7.3 Recording Control

Press REC  button start recording. Meantime, the key indicator turns on.

During recording, press PAUSE  button the recording pause, and press PAUSE button again

recording continue. Press REC  button, recording stops and save the video file to SD card.

Record video resolution is same to SDI PGM output resolution. (Reference part 4.3)

The recording status shown beside the menu, including information of REC mark, recording time, available storage. See below image:



Note:

1. The record file will be saved to SD card only after pressing the REC button to stop recording. Otherwise, the record file might be corruption.
2. In case the switcher is power off during record, the record file might be corruption.
3. If you want to change the PGM output resolution during recording, please stop recording and save the file first, then new record the video in new resolution. Otherwise, the record video files in SD card will be abnormal.

4.7.4 Recording Settings

Entering into the recording settings in main menu, and set the encoding format of the recording between VBR and CBR. User can also choose the video recording quality they need , there is Ultra High, High, Medium, Low for choice.

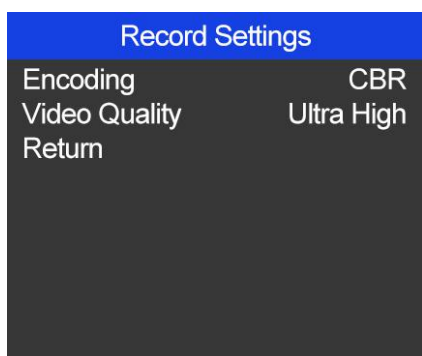

5. Main Menu Setting

When STATUS menu is not selected, press the MENU button to enter into main menu directly. In case one of the item is selected(see below), rotate the MENU button rotate anticlockwise to exit the choice, then press the MENU button to enter into main menu.

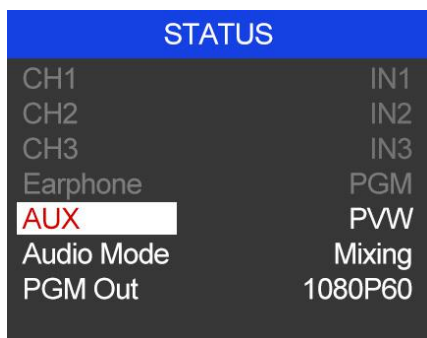

5.1 System Settings

5.1.1 Language

Entering system settings from the menu to switch the system language between English and Chinese.

5.1.2 Clock

Entering system settings from the menu to switch the real-time clock shown in Analog or Digital.

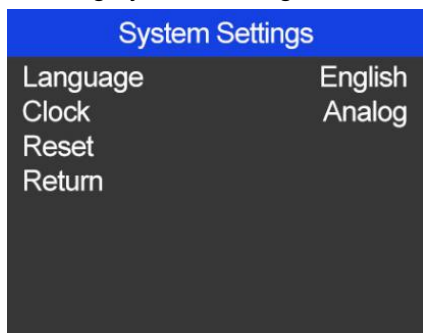

5.1.3 Clock Time Setting

Connect video switcher to a PC and download a time control software from AVMATRIX official website www.avmatrix.net/download/ Open the software and click Scan to search and connect the device, then the clock time will be changed to same time to the PC's time.

5.2 Network Settings

5.2.1 Network

There are two ways to acquire the IP: Dynamic(IP configured by router) and Static(set IP freely by yourself) . Select the method you need by knob menu. The default setting is Daynamic.

Dynamic: Connecting the video switcher with a router with DHCP features, then it will auto obtain an IP address automatically. Make sure that the video switcher and PC are in the same local area network.

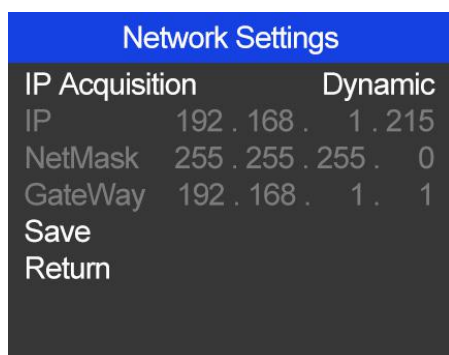

Static: Select static IP acquire method when the PC is without DHCP. Connect the video switcher with PC via network cable, set the PC's IP address to the same IP range as video switcher(the video switcher's default IP address 192.168.1.215), or set the video switcher's IP address to the same IP range as PC's IP address.

Network Settings	
IP Acquisition	Static
IP	192 . 168 . 1 . 215
NetMask	255 . 255 . 255 . 0
GateWay	192 . 168 . 1 . 1
Save	
Return	

5.2.2 NetMask

Set the NetMask. The default setting is 255.255.255.0.

5.2.3 GateWay

Set the GateWay according to current IP address.

Save the configuration when network setting finish.

5.3 Record Settings

Refer to 4.7.4

AVMATRIX[®]
www.avmatrix.net