

# TouchMix™

## User Guide

---

QSC™

### Firmware Version 2.1

TouchMix-8

TouchMix-16



TD-000472-01-C



## EXPLANATION OF SYMBOLS

The term "**WARNING!**" indicates instructions regarding personal safety. If the instructions are not followed the result may be bodily injury or death.

The term "**CAUTION!**" indicates instructions regarding possible damage to physical equipment. If these instructions are not followed, it may result in damage to the equipment that may not be covered under the warranty.

The term "**IMPORTANT!**" indicates instructions or information that are vital to the successful completion of the procedure.

The term "**NOTE**" is used to indicate additional useful information.



The intent of the lightning flash with arrowhead symbol in a triangle is to alert the user to the presence of un-insulated "dangerous" voltage within the product's enclosure that may be of sufficient magnitude to constitute a risk of electric shock to humans.



The intent of the exclamation point within an equilateral triangle is to alert the user to the presence of important safety, and operating and maintenance instructions in this manual.



### IMPORTANT SAFETY INSTRUCTIONS



**WARNING!** TO PREVENT FIRE OR ELECTRIC SHOCK, DO NOT EXPOSE THIS EQUIPMENT TO RAIN OR MOISTURE.

Maximum ambient operating temperature is 40°C (104°F).

**DO NOT LEAVE THE POWER SUPPLY UNATTENDED WHEN PLUGGED IN.** Always unplug the power supply from the electric outlet immediately after use.



**CAUTION!** Operate this unit with the QSC provided, Class 2 / LPS power supply only; do not substitute.

1. Read these instructions.
2. Keep these instructions.
3. Heed all warnings.
4. Follow all instructions.
5. Do not use this apparatus near water.
6. Do not submerge the apparatus in water or liquids.
7. Do not use any aerosol spray, cleaner, disinfectant or fumigant on, near or into the apparatus.
8. Clean only with a dry cloth.
9. Do not block any ventilation opening. Install in accordance with the manufacturer's instructions.
10. Keep ventilation opening free of dust or other matter.
11. Do not install near any heat sources such as radiators, heat registers, stoves, or other apparatus (including amplifiers) that produce heat.
12. To reduce the risk of electrical shock, the power cord shall be connected to a mains socket outlet with a protective earthing connection.
13. Do not defeat the safety purpose of the polarized or grounding-type plug. A polarized plug has two blades with one wider than the other. A grounding type plug has two blades and a third grounding prong. The wide blade or the third prong are provided for your safety. If the provided plug does not fit into your outlet, consult an electrician for replacement of the obsolete outlet.
14. Protect the power cord from being walked on or pinched particularly at plugs, convenience receptacles, and the point where they exit from the apparatus.
15. Do not unplug the unit by pulling on the cord, use the plug.
16. Only use attachments/accessories specified by the manufacturer.
17. Unplug this apparatus during lightning storms or when unused for long periods of time.
18. Refer all servicing to qualified service personnel. Servicing is required when the apparatus has been damaged in any way, such as power-supply cord or plug is damaged, liquid has been spilled or objects have fallen into the apparatus, the apparatus has been exposed to rain or moisture, does not operate normally, or has been dropped.
19. The appliance coupler, or the AC Mains plug, is the AC mains disconnect device and shall remain readily operable after installation.
20. Adhere to all applicable, local codes.
21. Consult a licensed, professional engineer when any doubt or questions arise regarding a physical equipment installation.

# Maintenance and Repair

Advance technology, e.g., the use of modern materials and powerful electronics, requires specially adapted maintenance and repair methods. To avoid a danger of subsequent damage to the apparatus, injuries to persons and/or the creation of additional safety hazards, all maintenance or repair work on the apparatus should be performed only by a QSC authorized service station or an authorized QSC International Distributor. QSC is not responsible for any injury, harm or related damages arising from any failure of the customer, owner or user of the apparatus to facilitate those repairs.

## FCC Statement



**NOTE:** This equipment has been tested and found to comply with the limits for a Class B digital device, pursuant to Part 15 of the FCC Rules.

These limits are designed to provide reasonable protection against harmful interference in a residential installation. This equipment generates, uses and can radiate radio frequency energy and, if not installed and used in accordance with the instructions, may cause harmful interference to radio communications. However, there is no guarantee that interference will not occur in a particular installation. If this equipment does cause harmful interference to radio or television reception, which can be determined by turning the equipment off and on, the user is encouraged to try to correct the interference by one or more of the following measures:

- Reorient or relocate the receiving antenna.
- Increase the separation between the equipment and receiver.
- Connect the equipment into an outlet on a circuit different from that to which the receiver is connected.
- Consult the dealer or an experienced radio/TV technician for help.

## RoHS STATEMENT

The QSC TouchMix-8 and QSC TouchMix-16 audio mixers are in compliance with European Directive 2011/65/EU – Restriction of Hazardous Substances (RoHS).

The QSC TouchMix-8 and QSC TouchMix-16 audio mixers are in compliance with “China RoHS” directives. The following chart is provided for product use in China and its territories:

QSC TouchMix-8 and QSC TouchMix-16 Audio Mixers						
部件名称 (Part Name)	有毒有害物质或元素 (Toxic or hazardous Substances and Elements)					
	铅 (Pb)	汞 (Hg)	镉 (Cd)	六价铬 (Cr(vi))	多溴联苯 (PBB)	多溴二苯醚 (PBDE)
电路板组件 (PCB Assemblies)	X	O	O	O	O	O
机壳装配件 (Chassis Assemblies)	X	O	O	O	O	O

O: 表明这些有毒或有害物质在部件使用的同类材料中的含量是在 SJ/T11363\_2006 极限的要求之下。  
(O: Indicates that this toxic or hazardous substance contained in all of the homogeneous materials for this part is below the limit requirement in SJ/T11363\_2006.)

X: 表明这些有毒或有害物质在部件使用的同类材料中至少有一种含量是在 SJ/T11363\_2006 极限的要求之上。  
(X: Indicates that this toxic or hazardous substance contained in at least one of the homogeneous materials used for this part is above the limit requirement in SJ/T11363\_2006.)

## Warranty

For a copy of the QSC Limited Warranty, visit the QSC Audio Products website at [www.qsc.com](http://www.qsc.com)

# Table of Contents

---

<b>Maintenance and Repair</b> .....	<b>.iii</b>
<b>FCC Statement</b> .....	<b>.iii</b>
<b>RoHS STATEMENT</b> .....	<b>.iii</b>
<b>Warranty</b> .....	<b>.iii</b>
<b>TouchMix™ How To</b> .....	<b>1</b>
<b>Register and Update</b> .....	<b>1</b>
<b>TouchMix Package Contents</b> .....	<b>1</b>
<b>Getting Started</b> .....	<b>1</b>
Turn off Demo Mode .....	1
Recall a Factory Scene .....	1
<b>Build a Mix Using Presets</b> .....	<b>2</b>
<b>Name Your Auxiliary Outputs</b> .....	<b>3</b>
<b>TouchMix Effects</b> .....	<b>3</b>
Effects Assignment Example .....	3
Name the Effects Channels (or Mixes) .....	4
Using the FX Wizard .....	5
Using the Input Channel FX Tab .....	6
Using the FX Channel Effect Tab .....	7
Using the FX Overview .....	8
<b>Mute Groups</b> .....	<b>8</b>
<b>DCA Groups</b> .....	<b>9</b>
<b>Save Your Work in a Scene</b> .....	<b>9</b>
<b>Connecting Remote Devices</b> .....	<b>10</b>
Create Own (TouchMix) Network .....	10
Wireless Connection to Existing Network .....	10
Wired Connection to an Existing Network Using Static IP Addresses .....	11
Wired Connection to an Existing Network Using Automatic IP Addresses .....	11
Troubleshooting .....	11
<b>Homework Completed</b> .....	<b>12</b>

<b>Sound Check</b> .....	<b>12</b>
Level-Match Your QSC Speakers .....	12
QSC GXD Amplifier Settings .....	13
Phantom Power (+48V) .....	13
Work on Your Inputs .....	13
Simple and Advanced Mode .....	13
Auxiliary (Stage Monitor) Mixes .....	14
Input by Input .....	14
Mix by Mix .....	14
Output Processing .....	14
EQ Tab .....	15
Limiter Tab .....	15
Filters Tab .....	15
Presets Tab .....	15
Setup Tab .....	16
Recording .....	17
Recording Directory Structure .....	18
Playback .....	18
Mix Down .....	18
<b>Security</b> .....	<b>19</b>
To Access Security Setup .....	19
To Lock the Mixer Manually .....	19
To Lock the Mixer with the Auto Lock Timer .....	19
Using the Security Features .....	19
<b>Tips &amp; Tricks</b> .....	<b>20</b>
<b>Low-Cut Filters (AKA High Pass Filters)</b> .....	<b>20</b>
Compressor Latch .....	20
About Effects Routing .....	21
<b>About DCA Groups</b> .....	<b>23</b>
<b>About the TouchMix Compressor Display</b> .....	<b>23</b>

<b>TouchMix™ Reference</b> .....	<b>24</b>
<b>Getting to Know Your TouchMix</b> .....	<b>24</b>
<b>Left Side of the TouchMix-16 Mixing Surface</b> .....	<b>24</b>
<b>Left Side of the TouchMix-8 Mixing Surface</b> .....	<b>24</b>
<b>Right Side of the TouchMix-16 Mixing Surface</b> .....	<b>25</b>
<b>Right Side of the TouchMix-8 Mixing Surface</b> .....	<b>26</b>
<b>TouchMix-16 Back Panel</b> .....	<b>27</b>
<b>TouchMix-8 Back Panel</b> .....	<b>27</b>
<b>Home</b> .....	<b>28</b>
<b>The Nav (Navigation) Strip</b> .....	<b>28</b>
<b>Where and What Things Are on the Home Screen Channels</b> .....	<b>29</b>
<b>Input Channel</b> .....	<b>30</b>
<b>Input Channel – Trim</b> .....	<b>30</b>
<b>Input Channel – EQ</b> .....	<b>31</b>
<b>Input Channel – Compressor</b> .....	<b>32</b>
<b>Input Channel – Gate</b> .....	<b>33</b>
<b>Input Channel – FX Sends</b> .....	<b>34</b>
<b>FX Signal Flow</b> .....	<b>34</b>
<b>Input Channel – Pitch Correct</b> .....	<b>35</b>
<b>Input Channel – Aux Sends</b> .....	<b>36</b>
<b>Auxiliary Channels Flow Diagram</b> .....	<b>36</b>
<b>Input Channel – Presets</b> .....	<b>37</b>
<b>Input Channel – Setup</b> .....	<b>38</b>
<b>Output Channel</b> .....	<b>39</b>
<b>Output Channel – EQ</b> .....	<b>39</b>
<b>Output Channel – Limiter</b> .....	<b>40</b>
<b>Output Channel – Filter</b> .....	<b>41</b>
<b>Output Channel – Presets</b> .....	<b>42</b>
<b>Output Channel – Setup / Delay</b> .....	<b>43</b>
<b>Output Channel – Speaker Settings</b> .....	<b>44</b>
<b>Output Channel – QSC GXD Amplifier Settings</b> .....	<b>45</b>
<b>Aux Overview</b> .....	<b>45</b>

<b>FX Masters</b> .....	<b>46</b>
FX Masters – Effect .....	46
FX Masters – EQ .....	46
FX Masters – Preset .....	47
FX Masters – Setup .....	48
FX Overview .....	48
<b>FX Processors</b> .....	<b>49</b>
FX Processors – Basic Chorus .....	49
FX Processors – Dense Reverb .....	50
FX Processors – Lush Reverb .....	50
FX Processors – Mono and Stereo Delay .....	51
FX Processors – Pitch Shift .....	51
Menu .....	52
Scenes .....	53
Security .....	54
DCA Groups .....	55
About DCA Groups .....	55
Aux Overview .....	55
Remote Control Settings .....	56
FX Overview .....	56
MIDI Setup .....	57
User Buttons .....	58
Mixer Setup .....	59
Talkback / Noise .....	60
Phantom Power .....	60
<b>Network Setup</b> .....	<b>61</b>
Wireless Network Setup .....	61
Wired Network Setup .....	62
Network Troubleshooting .....	62
<b>Mute Groups</b> .....	<b>63</b>
About Mute Groups .....	63
Mute Groups Mute Screen .....	63
Mute Group Edit Screen .....	63
<b>Phones and Monitor</b> .....	<b>64</b>
<b>Record / Playback</b> .....	<b>65</b>
Main Screen .....	65
Recording Setup .....	66

<b>2-Channel – Playback and Record</b> .....	<b>67</b>
2-Track Recording Setup .....	67
2-Track Playback EQ.....	67
<b>Wizard</b> .....	<b>68</b>
FX Wizard .....	68
Gain Wizard .....	69
<b>Aux Mix-on-Faders</b> .....	<b>69</b>
<b>Dimensions</b> .....	<b>70</b>
TouchMix-8.....	70
TouchMix-16.....	71
<b>Specifications</b> .....	<b>72</b>
<b>TouchMix Block Diagram</b> .....	<b>73</b>



# TouchMix™ How To



**IMPORTANT:** This User Guide applies to mixers with Firmware Version 2.0 installed. Earlier firmware releases do not support all of the functions described and some operations may differ.

## Register and Update



We know you want to get right to using your TouchMix, but before you do please stop and take a moment to visit [www.qsc.com](http://www.qsc.com) and register your TouchMix. By registering you can...

- Download TouchMix firmware so that your mixer has all the latest features, refinements and performance enhancements.
- Sign up to be notified of future updates.
- Check to see if you are eligible for free extended warranty coverage.

While you're there, you can also find videos and other tools to help you get the most from your TouchMix.

## TouchMix Package Contents

- |   |   |
|---|---|
| 1. Quick-Start Guide (TD-000445 or TD-000446) | 1. USB Wi-Fi adaptor (installed in mixer's USB port)                |
| 1. Warning Information Sheet                  | 1. Power supply with IEC cable (AC connector type varies by region) |
| 1. Limited Warranty (TD-000453-01 English)    | 1. TouchMix carrying case   |
| 1. TouchMix-16 or TouchMix-8                  |   |

## Getting Started

You just got your new TouchMix and can't wait to try it out on your next show. But since TouchMix is a digital mixer there are lots of things you can do off-line to save time during setup and help you get acquainted with your mixer. We highly recommend spending a little quality time with the mixer before taking it to a show for the first time.

### Turn off Demo Mode

Demo mode is a looping slide show that plays on the TouchMix as a factory default to give prospective buyers an overview of the mixer. Once you have purchased your TouchMix, you'll probably want to turn Demo Mode off – even though our graphics guys are really proud of how it looks.

To Disable Demo Mode:  ►  ► Demo Mode: Off 

### Recall a Factory Scene

#### *What is a Scene?*

A Scene is a group of settings that are saved and can be recalled at a later time. A Scene includes all channel-processing settings, channel Names, Phantom Power settings, Effects selections, DCA and Mute Group assignments. Scenes also include level settings. Factory scenes are stored with input faders at minimum to prevent any surprises (feedback, music at 20 dB above the threshold of pain, etc.) when the scene is recalled.

QSC loads TouchMix with pre-defined scenes for various kinds of performances. You can find the one that's most like the show you'll be mixing and start there.

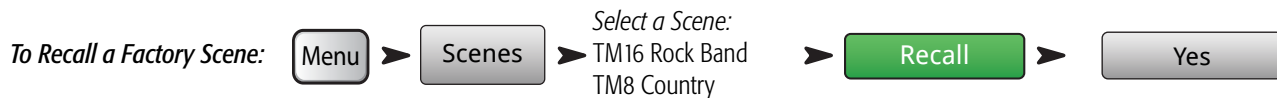

You'll see a list of Factory programmed scenes. Select one and touch Recall. Once you've recalled a scene you can make modifications to suit the show you're mixing.

The factory scenes list includes a scene named **Default**. This scene will "zero" the mixer by returning all controls to their factory settings.

If you'd like to navigate around the mix and see what the recalled settings are, return to the Home screen.

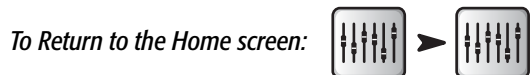

## Build a Mix Using Presets

### What is a Channel Preset?

A Channel Preset is a group of settings, for a single channel, that are saved and can be recalled for use at a later time. A Channel Preset includes the channel Name, Phantom power setting, and values for the channel EQ, Compressor, and Gate.

You can start by recalling channel Presets individually. TouchMix Presets were programmed to work with common microphones in real, live sound applications by skilled and experienced concert-sound mix-engineers. And they work. People who have used TouchMix report great results using the presets with little or no modification.



1. Make sure that the Factory / User switch is in the Factory position.
2. In the left window you'll see a list of instrument categories. Touch an instrument category name and a list of specific instruments appears in the middle window.
3. Select a type of instrument and the right window will display a list of options for the instrument. There may be options with and without gates and compressors as well as options for various types of microphones and pick-ups or different styles of music. Select the one that seems best for your application.

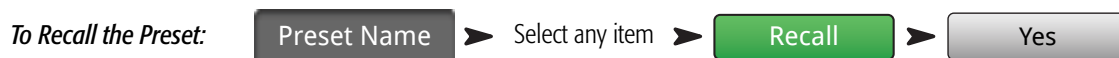

You've just dialed in the settings for an input channel. You'll also notice that the channel has been given a name that corresponds with the instrument you selected. You can leave the name as is or rename the channel.

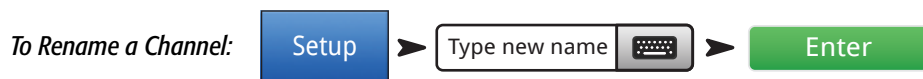

Repeat the process until you've set up all the channels you need.

# Name Your Auxiliary Outputs

## What is an Auxiliary?

In addition to the Main L/R (left/right) output mix, TouchMix-16 is also capable of controlling eight additional output mixes (six mono and two stereo). TouchMix-8 has four mono Aux outputs). These additional mixes are known as Auxiliaries, or “Auxes” for short.

The auxiliary outputs are typically used to drive stage monitor speaker systems or in-ear monitors (IEM) for performers. In some instances they may be used for a recording mix, audio feed to video or a send to an overflow area. In any case, it makes sense to label the auxiliary outputs to help keep them straight during use. Type in a name for the output – it could be the name of the performer who gets that mix or it could be something like “Singers” or “Horns” or “Video” or “Patio”.



## TouchMix Effects

Audio effects (FX) such as reverb, delay, chorus, pitch shift (pitch change) and pitch correct are essential in today’s audio production. TouchMix provides many users with more and better effects processing than they’ve ever had before. Using effects can be a bit intimidating so this section helps you use your TouchMix most effectively.

See ["Tips & Tricks" on page 20](#) to learn more about effects.

Imagine this – inside TouchMix is a virtual equipment warehouse. In the warehouse are 24 effects processors ready for use on the four FX mixes (FX1 – FX4). There are...



*Four Lush Reverb Processors*



*Four Pitch Shift Processors*



*Four Dense Reverb Processors*



*Four Mono Delay Processors*



*Four Chorus Processors*



*Four Stereo Delay Processors*

You can choose any combination of four in your mix. You can have a different Processor assigned to each effects mix, use four instances of the same processor or mix and match as you like.

Each of these processors have multiple presets. The reverb processors, for example have presets simulating various sizes of rooms and halls as well as reverb plates. In addition, there are brighter and darker sounding variations.

Along with the above effects, there is a Pitch-Corrector effect that can be assigned to any one of the input channels.

## Effects Assignment Example

The first thing to think about is what you want to do with your effects. Here’s a band input list that includes effects. The effects listed correspond with the factory default presets. Don’t be afraid to use the factory default settings. We chose them to be generally useful in lots of situations. In this example:

- The lead vocal is sent to a 250 msec. delay that is mixed in at a low level to provide a bit of thickening.
- Horns and all the vocals are given a bit of “space” with a Medium Hall Reverb.
- The snare and toms all have a Medium Plate Reverb applied to them. (Plate reverb is a go-to effect for drums.)
- Note that you can send a channel to more than one effect. Here, the horns are also sent to a Pitch Shift effect with a Light Detune preset. This will provide a subtle doubling of the horns.

- Other instruments either don't need any effects or have their own effects (guitar pedals, internal effects on keyboards).

Input	Instrument	FX Send	Effect Processor	FX Preset Name
1	Kick			
2	Snare	3	Dense Reverb	D Live Plate Med
3	Hi Hat			
4	Rack Tom	3	Dense Reverb	D Live Plate Med
5	Floor Tom	3	Dense Reverb	D Live Plate Med
6	Overhead R			
7	Overhead L			
8	Bass			
9	Guitar			
10	Sax	2 4	Lush Reverb Pitch Shift	L Med Hall Light Detune
11	Trumpet	2 4	Lush Reverb Pitch Shift	L Med Hall Pitch-Light Detune
12	Keys R			
13	Keys L			
14	Lead Vocals	1 2	Mono Delay Lush Reverb	Mono 250 Delay L Med Hall
15	Backing Vocal	2	Lush Reverb	L Med Hall
16	Backing Vocal	2	Lush Reverb	L Med Hall

Once you've thought about what effects you want to use, you can go to your TouchMix and start setting up your effects. Following are several ways to set up and control your TouchMix effects.

## Name the Effects Channels (or Mixes)

Before we start using the effects, let's take a moment to name our effects channels.

In the middle of a show it's easy to forget which effect was intended for what instruments. You can name the effects mixes to help keep track. For example, you might name an FX channel "Voc Delay" or "Drum Rev".



## Using the FX Wizard

The FX Wizard is the easiest and fastest way to set up your effects. Only effects that work for the Source and Type of input you have selected will be shown. So any effect you select using the wizard will be a valid one although it may or may not work in the context of your mix.

Here's how to use it.

**To Select and Assign Effects (FX) Using the Wizard:** Wizard → FX Wizard → FX1

You're now looking at the Wizard for FX1.

**Select a Preset:** Source → Type → FX Style

1. Use the Master Encoder or touch-and-drag to scroll up and down the list to see all the selections. Select one item from each list.
2. Touch **Recall**. The Preset is now loaded, and the name is displayed below the Type window.
3. With the Preset loaded, it's time to decide which input channels you're going to send (or feed) to FX1.

**Select Inputs to feed FX1:** In 1 through Stereo in 19/20

The buttons under "Select Inputs to feed" represent the input channels. Just decide which channels you want the effect to apply to and touch the corresponding button. The selected channels are now feeding the effect processor.

**Adjust Effect Master (Return) Level:**



4. Use the FX1 Master fader to adjust the amount of effect heard in the main mix.

**Send the Effect to Monitors:** Aux 1 through Aux 9/10

5. Is the performer going to want to hear the effect in the stage monitors or in-ear monitors? If so, it's easy to send it there. Just use the "Select Aux Outputs (monitors) to receive: FX1" buttons to tell your mixer where the effect should go.
6. You've still got three more effects available so touch one of the tabs at the top of the screen to set up another effect.

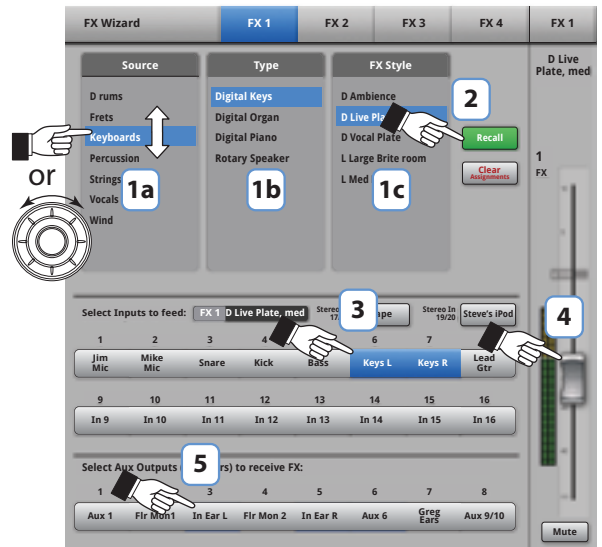

– Figure 1 –

Note: TouchMix App is shown, TouchMix display is slightly different.

## Using the Input Channel FX Tab

You can also operate your effects from the input channel area of your mixer.

*To Run Effects from the Input Channel:*



Welcome to the channel FX screen. From here you can...

*Select a Different Processor:*

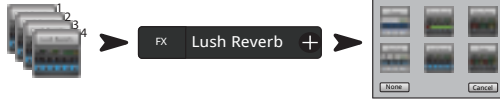

*Select a Preset:*



See "[Select a Preset:](#)" on page 5. Press Home to come back.

*Send to the Effect:*



Adjust the fader for each effect you want to use on this channel.

*Adjust Global FX Parameters (Advanced Mode Only):*



These controls are called "global" because all channels using this FX mix are affected by these controls. The Sends fader, however is adjusted for each individual channel.

*Using Pitch Correct:*



There is one Pitch-Correct processor available on the mixer. Touch the Enable button to assign it to the currently selected channel.

- Use the Blend control to vary the mix between corrected (wet) and uncorrected (dry) signal. 100% wet is used to correct pitch. A blend between wet and dry is used to provide a doubling effect.
- Use the Key control to select a musical key. This helps Pitch Correct be more accurate in determining what the intended note is.
- Use the Correct Rate control to adjust how quickly the pitch correction tracks.

## Using the FX Channel Effect Tab

Go to the FX Channel Effect Tab (From the Input Channel FX tab):



The FX Master Effect tab offers control over advanced Effects functionality.



This is where you can select which processor is associated with the selected FX mix or channel.



You can also select a processor preset.

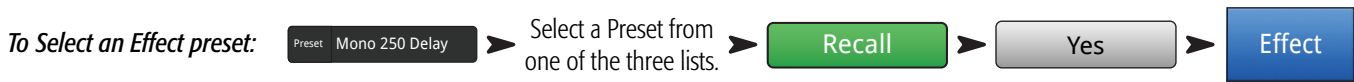

**NOTE:** Each processor has user adjustable parameters. Press **Info** then under **FX Panels** touch **<Effect Name>** for more information.

To Adjust the Level of the Effect Sent to the Main L/R Output:



Use the FX Master fader to the right of the FX panel to adjust the amount of effect heard in the main speaker system.

To Adjust the Level of the Effect Sent to the Auxiliary Outputs:  
TouchMix-8 Auxes 1-4, TouchMix-16 Auxes 1-6 and 7/8, 9/10.



Use the "FX Returns to Monitors" knobs to control the amount of effect heard in the monitor speakers.

The FX panel also includes EQ, Preset and Setup tabs. These function in the same way as the corresponding input channel screens.

## Using the FX Overview

If you would prefer to see the send and return levels for all your effects at once, the FX overview is where you want to go.

To use the FX Overview:  

1. The **columns** are the Input channels. Use the Nav Strip to change the group of Input channels. Each Input channel has its own FX Sends 1 – 4.
2. The **rows** are the FX Mixes. Each FX Mix has one FX Send from each Input Channel, an FX Master fader, and an Effect assignment ("none" can also be assigned).
3. **FX Master fader** – The FX Master fader controls the overall output level of the FX Mix to the Main L/R outputs. Note that the FX Master does not affect the level of the Effect sent to the Aux channels.
4. **Effect Processor** – Indicates the type of Effect currently being applied to the FX Mix.

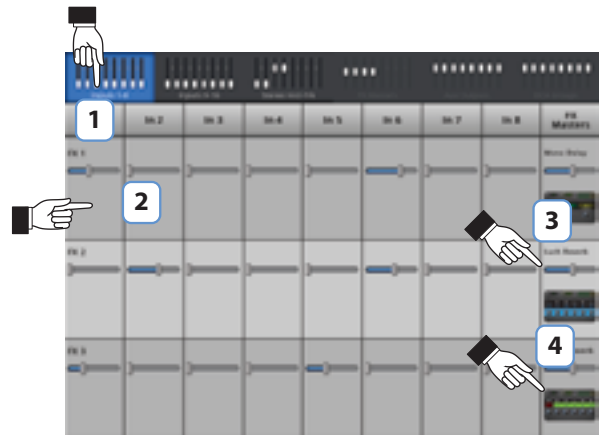

– Figure 2 –

So that's about it for effects. We worked hard on the TouchMix effects and know that they sound superb and will enhance your performances. You can dive in deep or just use the wizards, factory defaults and presets. Either way, you now have the tools for a great sounding show.

## Mute Groups

There are many times when it is useful to mute some of the inputs and outputs. For example, you might want to mute everything but a stereo input for break music. Or you may wish to mute all the musicians' channels when the pastor is speaking. Or there may be a part of your show when the band leaves the stage while one member does a solo number. Mute groups let you mute multiple inputs and outputs from a single button.

To set up Mute Groups:     Continue selecting channels as you wish.

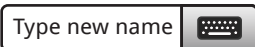
To Name the Mute Group: 

Select another Mute group to set up or touch Close Edit to finish.

To use Mute Groups:   



**NOTE:** When a channel is muted by a Mute Group, the channel Mute button on the Home screen looks like:





# DCA Groups



**TIP:** See "[Tips & Tricks](#)" on page 20 for more on DCA's.

A DCA groups faders together so the overall level of all the channels in the group can be controlled by a single DCA fader. A DCA fader does not change the position of any of the faders in the group.



**IMPORTANT:** Here is an important thing to know – if the DCA master fader is at 0.0 (the unity (U) mark), it does nothing to the level of an assigned channel. The DCA adds or subtracts level. Move the DCA Fader up 3 dB and everything it's assigned to will increase by 3 dB. Move it down 3 dB and – well you probably figured that out. Remember that assigning or unassigning a channel to a DCA Group can cause a sudden change in the level of the channel so it's good practice to have the DCA master at 0.0 when changing assignments.



You can assign inputs, outputs and FX Master faders to a DCA. If you assign an input, and the output to which it's going to the same DCA, changes you make using the DCA are doubled for the input. Raise the DCA 3 dB, the input is effectively raised 6 dB.

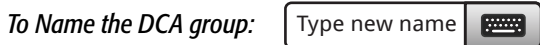

When you mute a DCA, all channels assigned to that DCA are muted. If a channel is muted by the channel Mute button, or a Mute Group, the DCA does not un-mute the channel when the DCA is un-muted.

## Save Your Work in a Scene

You've put some effort into setting up your mix so now would be a great time to save it. A Scene is a snapshot of all the settings on the mixer.



**TIP:** It's a good idea to save your scene with the outputs muted or levels down. Why? Because it's possible that the gain settings on power amplifiers or powered loudspeakers have changed since the scene was saved. Recalling the scene could result in a blast of feedback from all the speakers connected to the mixer.

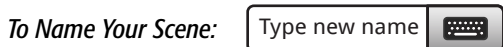

## Connecting Remote Devices

There are several ways to connect your wireless devices to TouchMix using the included Wi-Fi dongle or an external Wi-Fi router. See ""Remote Control Settings" on page 56" for more detail on allowing or restricting access by remote devices.

### Create Own (TouchMix) Network

Direct wireless connection between TouchMix and your devices.

Make sure the provided USB Wi-Fi adapter is installed in one of the mixer's USB ports.

To Create your own network:  ➤  ➤ 

Edit Settings for: 

Network Mode:  Create your own network

If desired enter a new Mixer Name and Network Password.



**NOTE:** The Network Name is constrained to ten characters available on the "Mixer Name" keyboard. The Password must be numeric and must contain ten digits.

Touch  When the mixer is connected, a confirmation message displays.

You can now connect your wireless device using the mixer's name (Network SSID) and Network Password.

### Wireless Connection to Existing Network

When this method is used, TouchMix uses a wireless connection to an external router. Wi-Fi devices connect to TouchMix via the external router. Make sure the provided USB Wi-Fi adapter is installed in one of the mixer's USB ports.

To Connect to an existing wireless network:  ➤  ➤ 

Edit Settings for: 

Network Mode: Connect to an existing network 

If desired enter a new Mixer Name.

The Network SSID (name) and Password are set on the network to which you are connecting.

Touch the  button to select the network from a list of available wireless networks. Or, click in the Network SSID field and enter the network name

Enter the   for the network.

Touch  When the mixer is connected to the network, a confirmation message displays.

You can now connect your wireless device using the existing network's name (Network SSID) and Password.

## Wired Connection to an Existing Network Using Static IP Addresses

Install a USB-to-Ethernet adapter into one of the mixer's USB ports. Using an RJ45 cable, connect the adapter to a port on the router. The TouchMix firmware is optimized for adapters using the ASIX AX88772 chip-set. Visit [qsc.com](http://qsc.com) for a list of validated adapters.

To Connect to an existing wired network:  ➤  ➤ 

Edit Settings for: 

If desired, enter a new Mixer Name.

IP Address Assignment Static

Enter the IP Address   for the network.

Enter the Network Mask   for the network.

Enter the Gateway   for the network.

Touch  When the mixer is connected to the network, a confirmation message displays.

You can now connect your wireless device using the existing network's name (Network SSID) and Password.

## Wired Connection to an Existing Network Using Automatic IP Addresses

Install a USB-to-Ethernet adapter into one of the mixer's USB ports (visit [qsc.com](http://qsc.com) for a list of validated adapters). Using an RJ45 cable, connect the adapter to a port of the router.

To Connect to an existing wired network:  ➤  ➤ 

Edit Settings for: 

If desired, enter a new Mixer Name.

IP Address Assignment:  Automatic

Assigned Address: 192.168.1.1 (The actual address you get will probably be different than the example.)

Touch  When the mixer is connected to the network, a confirmation message displays.

You can now connect your wireless device using the existing network's name (Network SSID) and Password.

## Troubleshooting

In the network status box, you may get one or more of the following messages:





or



For troubleshooting Wi-Fi issues, refer to ["Network Troubleshooting" on page 62](#).

# Homework Completed

That's it. You've done your homework. Of course you'll need to adjust the input gain and get your mix levels at the gig but you're way more than half-way to a great, professional-sounding mix.

## Sound Check

Before connecting anything, plug in your TouchMix and make sure that all the inputs and Auxiliary Outputs are muted. This will prevent uncontrolled feedback if a microphone is patched into a hot channel.



In each of the groups of faders, press the Mute button for all channels. Now you can connect the mixer to sources and speaker systems.

## Level-Match Your QSC Speakers

If you're using one of the following QSC Loudspeakers:   OR  your TouchMix tells you the optimum input-gain setting for your loudspeaker.



In the popup all you need to do is touch the button associated with your loudspeaker, and then adjust your loudspeakers as instructed.

You're probably wondering - why we recommend using input B. Input A has a switch that adds gain for use with a direct microphone input. If this switch is set incorrectly the speaker's input will be far too hot. Using input B eliminates the possibility of such a mistake.

These settings will give you the optimum signal to noise performance and get the most from your QSC powered speakers. The mixer's output meters will reflect when you're "running out of speaker". Note that you will see the "Limit" light on your speakers illuminate as the mixer drives them harder during louder portions. This is normal and is just the speaker's internal DSP doing its job.

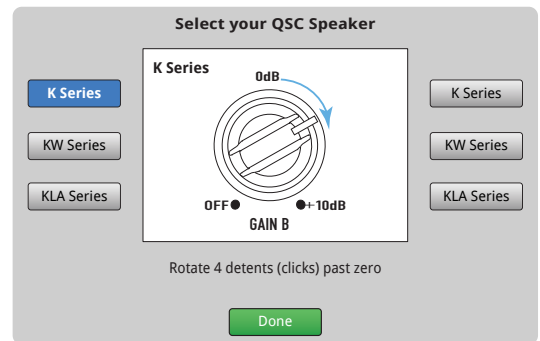

– Figure 3 –

## QSC GXD Amplifier Settings

If you are using a QSC GXD amplifier, you can optimize the gain and sensitivity for use with your TouchMix. Refer to ["Output Channel – QSC GXD Amplifier Settings" on page 45](#)

### Phantom Power (+48V)

Most condenser microphones and some direct boxes require phantom power from the mixer. On TouchMix, phantom power may be turned on or off on a per channel basis. Make sure that phantom power is on for those channels that need it and off for those that don't.

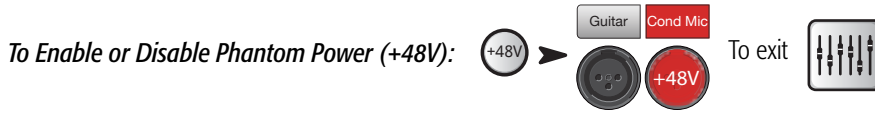

Phantom power is also accessible from the channel Setup screens.

### Work on Your Inputs

Ask the performers in turn to do what they do to make their audio contribution to the performance. Without un-muting their channels, bring the channel's input gain Trim up while watching the channel meter on the Home screen. What you are looking for is a meter that is bouncing around the 0 mark when the performer is producing a normal output level.



**TIP:** During sound check performers will usually not play as loudly as they do in an actual performance so keep this in mind and allow a little extra headroom.

With the performer performing, un-mute the channel and bring the fader up until the desired performance level is reached.

If you are using one of the internal channel presets, this channel should already be sounding good. If it's not what you're looking for, try some of the other preset choices. For most instruments and musical styles, there will be a preset that works well. If not, you'll need to dive into the channel and dial it in manually.



At the top of the screen, select the tab for the channel processing element you want to work on.

### Simple and Advanced Mode

TouchMix offers two modes of operation.

- **Simple Mode** – Presents the user with a reduced set of controls. It's important to know that switching into Simple mode does not alter the values of any Advanced-mode controls.
- **Advanced Mode** – Presents all mixer controls to the user.

You can select Simple and Advanced modes individually for an EQ, Gate, Compressor or Effect. Note that the Stereo and Mono Delays do not have a Simple mode. Look for the Simple button on the screen. Or you can make the selection globally.

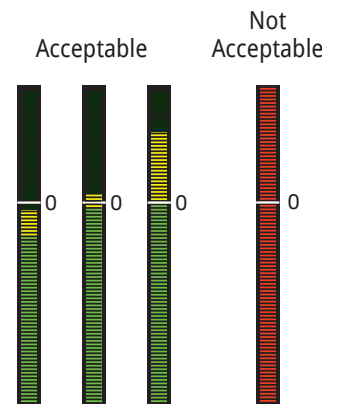

– Figure 4 –

## Auxiliary (Stage Monitor) Mixes

There are two general approaches to setting up stage monitor mixes:

### Input by Input

With all the performers on stage, ask each performer in turn to play or sing just one thing (Kick, Snare, Guitar, Sax, etc). Ask each performer how much of that instrument they want in their monitor. Our guess is that they will all say “that’s plenty” during sound check and then ask for lots more after the first song – just sayin’.



You will see sliders representing the send levels to all the aux mixes. Auxes 7/8 and 9/10 are stereo auxes so each has a Pan control. If any mono auxes are linked they also have Pan controls.



### Mix by Mix

In this approach, you'll dial in a complete monitor mix for one performer at a time. There are two ways of doing this.

#### Overview Screen

One way is from the Aux Overview screen. The Aux Overview screen, as the name implies, provides a view of all the aux mixes for a bank of channels at once, in matrix format.



Each horizontal row of sliders represents one of your monitor mixes. If you have named your Aux outputs, the name displays above the Master slider on the right of the screen. Auxes 7/8 and 9/10 are stereo auxes so each has a Pan control. If any mono auxes are linked they also have Pan controls.



#### Mix-on-Faders

This screen presents the controls for one Aux Mix at a time using the same style of large faders as the Home screen.



Touch the Aux Mix Select to go to the mix you want, then use the faders to adjust the sends to the selected Aux Mix. If necessary, select another bank of channels. Mix-on-Faders is the perfect method for a performer using the TouchMix App to dial in their own stage monitor – they see only the channel sends for their monitor.

## Output Processing

Like the input channels, the outputs (Main L/R and Aux Outputs) have their own processing.

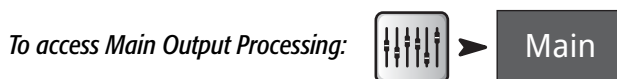

## EQ Tab

For the Main and mono Aux outputs, the EQ tab displays the 1/3 octave graphic equalizer. To better fit the screen, the equalizer has been divided into four sections – Low, Low-Mid, High-Mid and High. The four windows will display the setting of all faders. Touch any of the windows to work on that part of the frequency spectrum.

For Auxes 7/8 and 9/10 (TouchMix-16 only) the EQ is parametric and is identical to that found on input channels.

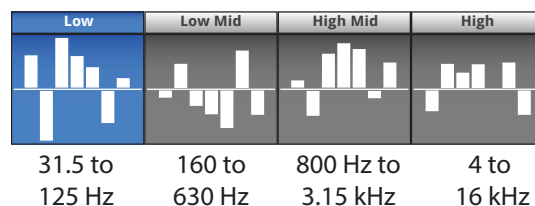

– Figure 5 –

## Limiter Tab

Displays the limiter and its controls. We strongly encourage the use of the limiter for In Ear Monitors.

## Filters Tab

There are multiple types of filters presented here.

- **Low-Cut / High-Cut filters** – These filters are used to roll off high or low frequency content. There are a number of possible applications. See Tips & Tricks for more on Low and High-Cut filters.
  - For **stage monitors**, it is common to roll off low frequencies at 80 – 100 Hz. There is usually ample low frequency energy on stage without any help from the monitors. Keeping it out of the monitors can reduce “rumble” on stage and in the house.
  - For **speech** only systems, rolling off low frequencies can reduce microphone handling noise or, if outdoors wind noise.
  - **Fill speakers** may not need any additional low-frequency energy as there is ample bottom end coming from subwoofers.
  - There is a technique known as “**subs on auxes**” in which the subwoofer is fed from one of the auxes while the main speakers are fed from the mixer’s main outputs. Only those instruments that contain low-frequencies are sent to the subwoofer. This provides more control over the lows and can help keep the bottom end tighter. If this is being done, the Low and High-Cut filters could be used to set the crossover point between subs and main speakers.
- **Anti-Feedback Notch Filters** – These are very deep (up to -20 dB), very narrow cut only filters that can be quite effective in fighting feedback frequencies while doing little to alter the overall sound. Experienced engineers will bring the system up just to the edge of feedback while adjusting the frequency to tune out feedback. This must be done with care as the system is very close to uncontrolled feedback.

## Presets Tab

This tab offers a Factory Preset named Reset that returns all output control parameters to their factory values. In addition, any settings you make can be stored to or recalled from either internal or external (USB) memory.

## Setup Tab

**Name the Aux Output:**  

Touch to enter a new name for the output. (not available on Main output) to name the output.

**Linking:**

Available only on Auxes 1-8 (TouchMix-16), and 1-4 (TouchMix-8). This Links odd-to-even pairs of auxiliary mixes to create a stereo mix.

**Delay:**

Delay is most commonly used for remote fill speakers. The objective is to set the delay so that the sound from the primary system arrives at the listeners ears just slightly (20 – 30 msec) ahead of the sound from the fill system. When done correctly, the listeners perceive the sound as coming from the primary system even though most of what they hear is from the fill speakers.

In venues with very deep stages, the engineer will sometimes delay the house system so that it time aligns with the back-line. In other words, set up the system so that the sound from the actual kick drum and the reinforced kick drum arrive at the listeners' ears at the same time.

You can also drive your drummer nuts by delaying his monitor just a bit – but that wouldn't be very nice, would it?

The delay provides a read out in msec. (up to 100), meters (up to 34.3) and feet (up to 113).

**Speaker Settings:**

Refer to "[Level-Match Your QSC Speakers](#)" on page 12 for details.

**GXD Amp Settings:**

Refer to "[Output Channel – QSC GXD Amplifier Settings](#)" on page 45

**Aux Pick-off**

Available for the Aux mixes only, these buttons determine where the point from which the signal is taken is before or after the channel fader. For most monitor mixing applications, this should be set to Pre.

**Assignments**

And you didn't think there would be any assignments. But these aren't the kind of assignments that require homework. These buttons assign the output to a Mute Group or a DCA Group. Mute Groups and DCA Groups are discussed previously.



## Recording

TouchMix makes it easier than ever to capture a live performance in a stereo or a multi-track recording. All you need is a USB hard-drive.



**NOTE: Hard-drive requirements** – A list of hard-drives that QSC has qualified may be found at [qsc.com](http://qsc.com). There are far too many hard-drives available for us to test them all so there are certainly many unlisted drives that will work well with TouchMix. Higher speed drives (>7200 RPM) tend to work best. Some higher speed drives don't do their best when powered from the USB port but will work when used with an external power supply. We have also had very good luck with solid state drives. The drive must be formatted as FAT 32 and de-fragmentation improves seek time.

Be sure that there is sufficient space on the drive for your recording. To calculate the space required for your recording...

- **For 48 kHz** – Space required (in MB) = 8.64 x minutes x tracks
- **For 44.1 kHz** – Space required (in MB) = 7.94 x minutes x tracks

It is good practice to have more disk space available than you need. If the drive is nearly full, TouchMix has to look for nooks and crannies of available space. This will result in fragmented wave files and potential loss of audio data and synchronization across tracks. At approximately 3 hours of non-stop recording, the maximum file size supported by FAT32 is exceeded. To avoid problems, stop and then resume recording. It is not necessary to create a new session. TouchMix displays a pop-up that warns you when this limit is approaching. If you do exceed the FAT32 limit, track synchronization may be lost.







**NOTE:** Depending on the number of tracks recorded and the performance of the hard drive, multi-track playback may slow down the rendering of objects on the TouchMix screen resulting in lagging movement of controls.

In general, use 44.1 kHz for CD projects, and 48 kHz for video projects. Do not change sample rate while recording.

**To View or Change Sample Rate:**   

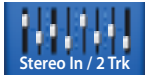
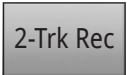
**To Select Channels for Recording:**    Repeat for all channels you wish to record.

All mixer inputs (TouchMix-16 – 20 inputs, TouchMix-8 – 12 inputs) may be recorded simultaneously. In addition, you can record the Main mix.

**To Select Stereo Mix to Record:**      



**NOTE:** Stereo record for Aux 7/8 and Aux 9/10 is available on the TouchMix-16 only.

**To Name a New Session:**     

## Recording Directory Structure

When you create a new Session, TouchMix creates a new folder on the USB drive named for the Session. Within the folder there is a folder for each channel. When you begin recording, the .wav files are written from the channels to their folders. If you start, stop and resume recording, additional .wav files are written in the folders each time you resume recording. If you don't arm a channel for recording, nothing is placed in that folder.



**IMPORTANT:** Do not unplug your TouchMix until you have stopped recording! If you do, your recorded tracks will not be usable. You must end the Session by touching the STOP button on the transport control. Doing so writes a header file that is needed in order to play back the recording or import it into a DAW.

You'll notice that in – Figure 6 Track1 contains sequential wave files named Region-1, Region-2, and so on. Each time a session is paused and resumed a new set of wave files is recorded. So, if you played 3 sets, stopping the recorder after each, you would find 3 wave files in each Track folder. These wave files can be imported into most DAW (Digital Audio Workstation) software. See your DAW's documentation.

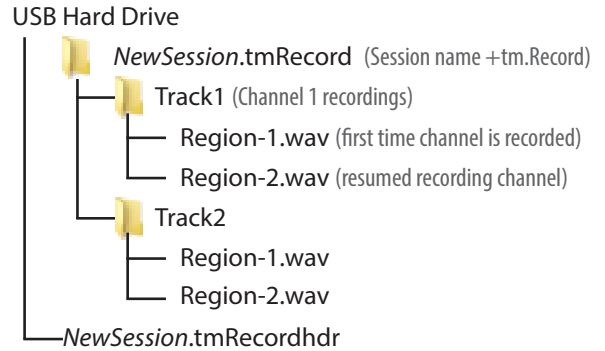

– Figure 6 –



**IMPORTANT:** If you plan to edit the files/folders in any way (even just opening and saving a file), make sure you make a copy of the files and use the copy for editing. If you change anything, the entire session cannot be used on the TouchMix for more recording or for playback.

## Playback

Tracks that you have recorded on the TouchMix may be played back and mixed down on your TouchMix. The first step is to load the Session you wish to play back.

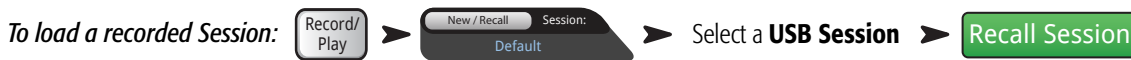

The next step is to select "Track" as the source for the mixer's input channels.



## Mix Down

There are three ways to mix down your multi-track recording.

- Import the multi-track waves into a DAW (digital audio workstation). See your DAW's documentation for instructions on importing files.
- Record the mixer's analog output to an external 2-track recorder. Simply connect the TouchMix Main L/R outputs to the inputs of your 2-track device.
- Internal mix down to 2-track. All input tracks can be recorded to a stereo mix.

To mix down to 2-tracks:

1. Recall the session and set up the mixer for Playback as described above.



3. *To begin recording:* Record/Play button -> Make sure that no other channels are armed for recording. -> Transport stop button.

4. Operate the transport normally.

The .wav files for the 2-track recording can be found in the session folders Track21 and Track22 (TouchMix-16,) or Track14 and Track15 (TouchMix-8).

# Security

The TouchMix security system allows limiting access to various mixer functions based on a password.

## To Access Security Setup



There are four levels of access provided.

- **Administrator** – Allows access to all mixer functions including the setting of passwords and preferences for security functions. Setting a password for Administrator enables the Security feature.
- **All Access** – Allows access to all mixer functions except Security Setup.
  - In addition, Overwrite Scenes & Presets, Recall Scenes, and Recall Presets can be allowed or denied by the administrator.
- **Simple Mode Only** – Allows access to all simple-mode mixer functions for screens having a Simple / Advance choice, and all other functions except Security Setup.
  - In addition, Overwrite Scenes & Presets, Recall Scenes, and Recall Presets can be allowed or denied by the administrator.
- **Levels Only** – Access to level controls only.
  - In addition, Overwrite Scenes & Presets, and Recall Scenes can be allowed or denied by the administrator.

## To Lock the Mixer Manually



## To Lock the Mixer with the Auto Lock Timer



When engaged the timer may be set so that the mixer will Lock after not being operated for 1 to 25 hours (24 hours and 60 minutes).

## Using the Security Features

To use the mixer without security, simply leave all the passwords blank. If lots of people have access to the mixer it might be a good idea to enter an Administrator password just to prevent someone else from taking over as Administrator – even if you aren't going to set up other security levels.

To set up a security level, simply enter a password for the security level and set the preset and scenes options as desired.



**NOTE:** Passwords are case sensitive. If you forget your password, call QSC Technical support.

If a security level is left blank, anyone with access to the mixer can operate it with the restrictions imposed by blank security level. So let's say you want to allow anyone to operate the mixer in Simple Mode. Enter passwords for Administrator and All Access. Give the All Access password to advanced users only. Everyone else can still operate the mixer in Simple Mode.

## To Log In

If a security level has been enabled and the mixer has been locked, the screen displays the QSC and TouchMix logos as well as a Login button.



You can now operate the mixer based on your security level.

If one or more security levels are left blank, the level shown in the Current Login field is the highest unsecured level.

Press the Home button to operate the mixer in the current Login level.

## Tips & Tricks

### Low-Cut Filters (AKA High Pass Filters)

Most small mixers lack this really useful feature. But once you learn how to use it, you'll never want to mix a show without it. There really are only a few instruments on stage like kick drum, larger toms, bass and keyboards that are even capable of producing low frequencies. For most everything else, low frequencies just cause problems. Even a low male voice doesn't produce frequencies much below 100 Hz. By using the low cut filter to eliminate low-frequencies from channels that have no lows, we can reduce microphone handling noise and potential feedback. And by keeping low frequencies from the bass and kick-drum out of (for example) the vocal microphones, we can keep these instruments sounding cleaner. Many of the TouchMix presets already include appropriate Low-Cut filter settings.

To set up a Low-Cut filter manually, just ask the performer to speak, sing or play in the lower register of their range. Raise the Low-Cut filter frequency until it begins to make the channel sound too thin. Then back it down until the thinness goes away. The Low-Cut Filter is handy on drum overheads, snares, hi-hats, horns, guitars and vocals.

Here's just one example of some of the things you can do with high and low cut filters. If you ever mike a Leslie® speaker, one neat trick is to take the Low-Cut filter for the top rotor channel up to 800 Hz. That's the cross-over frequency for a Leslie so anything below 800 Hz is going to be wind-noise from the rotor or bleed from other instruments. For the bottom rotor microphone – you guessed it – use the High-Cut filter set to 800 Hz.

### Compressor Latch

When the band is playing, everything is just fine but between songs the lead vocal microphone starts feeding back. What's going on? You may be a victim of Compressor Latch. Here's how it works. The compressor's threshold is set so that it is reducing channel gain pretty much all the time that the band is playing. During a song, the mixer operator brings up the lead vocal channel because it's not loud enough. Of course it's not loud enough, the compressor is bringing down the channel level all the time. Once the song ends though, the level coming in to the channel is no longer hot enough to reach the compressor threshold. So now, the compressor is not reducing channel gain. Without the gain reduction, the channel is unstable and starts taking off. The solution is to turn the channel down and raise the threshold setting of the compressor so that it is not reducing gain all the time. Think about it. If you're reducing gain all the time, you're really not compressing anything. You're just turning down the channel during a song and turning it back up again between songs.

## About Effects Routing

We have effects on a mixer because we want to apply them to one or more inputs in order to enhance the sound. This means that somehow the mixer has to be able to take the sound from selected input channels and "send" the sound to the effects processor. Back in the day, before mixers had effects processors built in, the audio was "sent" from an output (usually an Aux channel) to another box, the effects processor. The audio level sent to the Effects Processor was, and still is, controlled by a "send" control. The send controls how much audio is sent from an input channel to somewhere else – in this case, the Effects Processors. The TouchMix has four Effects Sends for each input channel. Each Send is connected to one of four FX Mixes (or channels). You can assign any one of the mixer's internal Effects Processors to each of the four FX Mixes.

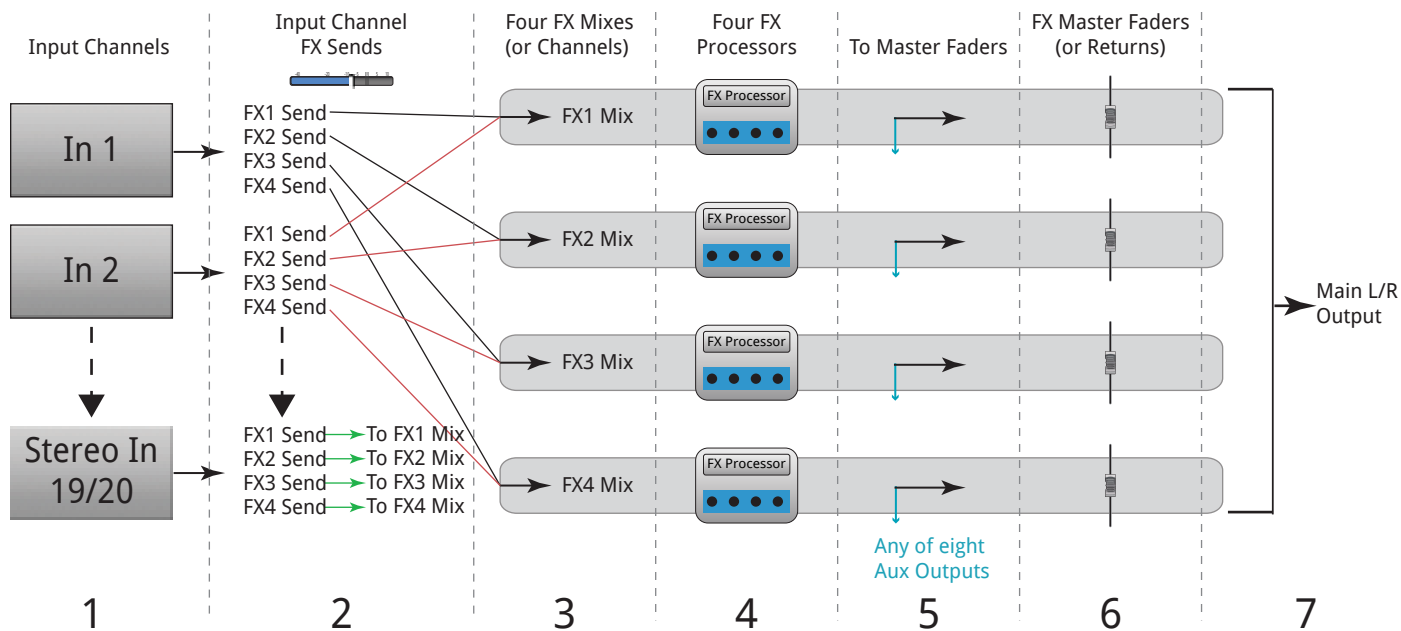

– Figure 7 –

1. Each Input Channel (1) has four FX Sends (2); FX1 through FX4.
2. The FX Sends control the level of the audio from the input channel(s) to the associated FX Mix (3) – FX1 Send controls the audio level to FX1 Mix.
3. Each FX Mix can be assigned only one FX Processor (4). The FX Processors can all be the same, or all different. The audio from all input channels sent to FX1 Mix is processed by the same Effect Processor.
4. After the audio is processed by the Effect, you can send that audio to any of the Aux Outputs (5).
5. The FX Master fader (6) controls the mixed output level of all FX'd input-channel audio sent to an FX mix.

– Figure 8 is a diagram of a single channel and one effects send and return. Lets walk through the diagram.

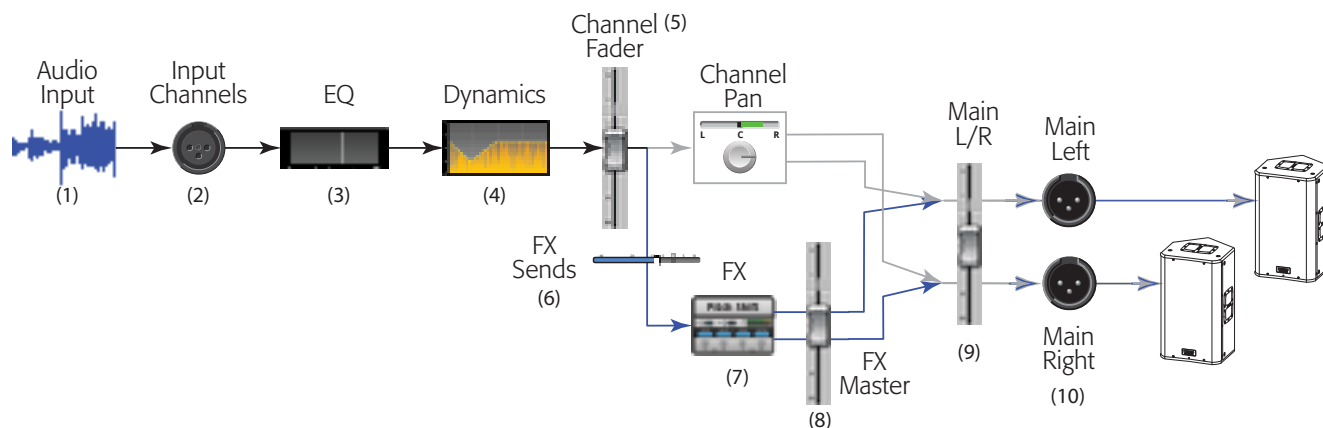

– Figure 8 –

1. Audio (1) is input via one of the TouchMix inputs (2).
2. The audio is then sent through the EQ processor (3).
3. After the EQ, it goes through the Dynamics (4) – Compressor and Gate.
4. Then the Channel Fader (5) does its thing. (Its thing is controlling the audio level being sent to the FX Sends.) After the channel fader, the audio is split to the following:
  - a. Channel Pan control, then to the Main outputs (follow the gray line in the diagram)
  - b. Effects processing (follow the blue line in the diagram)
5. The first stop in the Effects path is the Effects Send control (6). This controls the level of the audio sent to the selected Effects Processor from this channel.
6. The Effects Processor (7) takes the channel audio (mono), applies the selected effect, then creates a stereo output signal.
7. At this point, you have the option to send the FX'd audio to the Aux stage monitors for the people who want it in their monitor mix.
8. The stereo audio level is controlled by the FX Return (or Master) fader (8). It is called a return because again, back in the day, after the audio was "sent" to the Effects box it had to be "returned" to the mixer - clever eh? Since any of the channels can send audio to this Effects Processor, the audio from all of the channels using this Effects Processor is controlled by the FX Master (or Return) fader. You can easily see this if you look at the FX Overview screen.
9. The final step is mixing the audio from the input channel with the audio from the effects channel and sending it to the Main L/R fader (9) then to the Main L/R outputs (10). Remember, this example is just one channel. You'll probably have more than one channel, so all the Input channels are mixed with all the FX Return audio into the Main L/R outputs.



**NOTE:** There are four dedicated mixes feeding your effects so you don't have to "borrow" an aux mix.

So much for getting the channels' sound into the effects processor. How are we going to get the sound of the effect returned to the mix? Those same clever guys who came up with the "send" control, also came up with the idea of a "return" control. This is a control that determines how much of the effect is going to be returned and blended into the mix. Or maybe we should say "blended into the mixes". That's because the performers may want to hear the effect in their monitors. So the output of the TouchMix effects can be sent to the monitors as well as to the main speaker system.

There is one thing to be aware of when sending effects to the performers' monitors. Let's say that you are sending the sax and the lead vocals to the same reverb processor. You then return the reverb to both the saxophonist's monitor and the lead vocalist's monitor. But neither wants to hear the other in their respective monitors. Unfortunately, the vocalist is now going to hear sax with heavy reverb and the saxophonist is going to hear lead vocals coming out of a huge cave. The answer is to either forget about putting the reverb into the monitors or to use separate processors for each musician.

## About DCA Groups

What is a DCA? DCA stands for Digitally Controlled Amplifier. What this function does is allow a single fader to control the level of a group of channels. Let's say that you have your drum mix set up and it's perfect but the drums are just a bit hot relative to the rest of the mix. When you assign a DCA to all the drum microphones, you can pull down a single fader and bring down the level of all the drums at once without changing their mix.



**TIP:** The TouchMix allows a DCA master to control outputs as well as inputs. One of our favorite tricks is to assign all the stage monitor outputs (auxes) to a DCA. If the monitors start to feed back and you don't know which one is the problem, you can bring all the monitors down at the same time until you figure out what to do.

Consider what groups of things you might want to control at the same time. Here is an important thing to know – if the DCA fader is at 0.0 (the U mark), it will do nothing to the level of an assigned channel. The DCA adds or subtracts level. Move the DCA Fader up 3 dB and everything it's assigned to will increase by 3 dB. Remember that assigning a channel to a DCA Group can cause a sudden change in the level of the channel so it's good practice to have the DCA master at 0.0 when changing assignments.

## About the TouchMix Compressor Display

Dynamics processing (compressors, limiters) is not well understood by many users. This is probably due to the fact that the actions of compressors and limiters are subtle unless they are completely mis-adjusted. Most displays of dynamics processors use a graph that shows input level versus output level. But these displays don't capture the other important aspect of dynamics processing – time. The TouchMix dynamics display was developed to visually present time and level simultaneously. Looking at the display we see these indications.

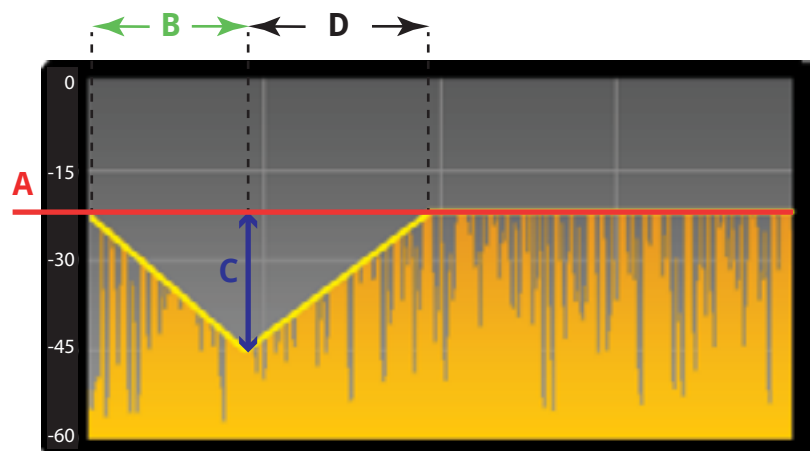

– Figure 9 –

A – Threshold. This indicates the level of the input signal that is required to cause compression or limiting to take place. As long as the signal remains below the Threshold level, it's as if the compressor / limiter didn't exist.

B – Attack Time. Once the input signal exceeds the Threshold level, the compressor / limiter goes to work and reduces signal level. Attack determines how quickly the compressor reduces the audio to the level set by the Ratio.

C – Ratio. This determines how much the signal is reduced in level once compression / limiting takes place. A ratio of 1:1 would mean that no reduction is taking place. While a ratio of 20:1 would indicate extreme compression.

D – Release Time. Once the signal level has dropped below threshold, the compressor will stop reducing the signal level. Release determines how quickly gain reduction ceases.

# TouchMix™ Reference

The information provided in this section gives you a detailed description of the screens and controls for the TouchMix and the TouchMix iPad App. The screen shots provided are taken from the TouchMix iPad App, and because of a different screen size, may appear slightly different than the TouchMix screens.

## Getting to Know Your TouchMix

### Left Side of the TouchMix-16 Mixing Surface

Refer to – Figure 10

1. Rear Panel labels
2. Balanced female XLR inputs (1–12)
3. Trim – Channels 1–16 adjusts input signal level prior to A/D conversion
4. Color LCD touchscreen
5. Balanced female XLR and 1/4" TRS combo inputs (13-16). The TRS connectors supply a +10dB pad.
6. Home – Navigates up the menu structure to the Home screen
7. Menu – Displays a choice of menu options, including Mixer Setup.
8. Record/Play – Displays recording controls and options.

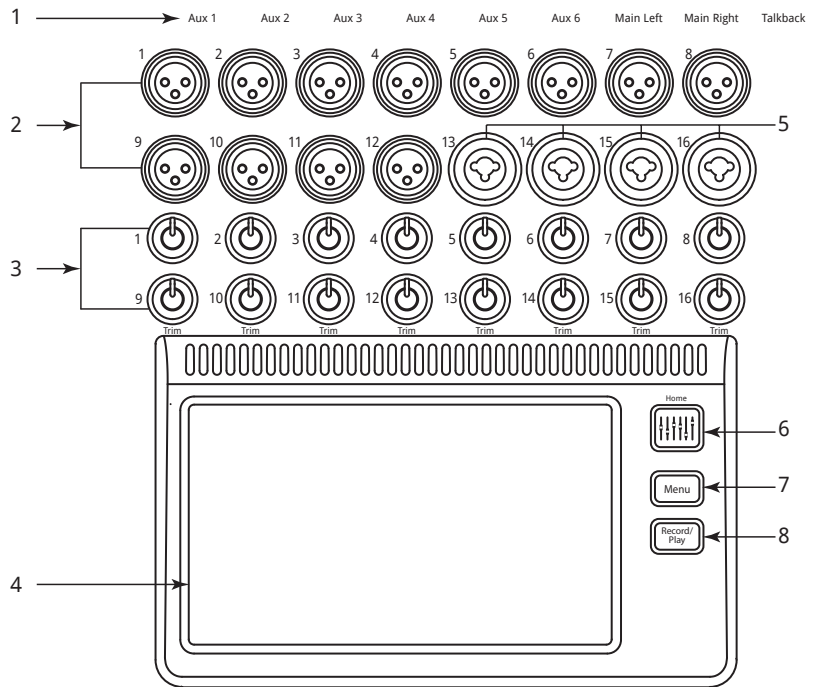

– Figure 10 –

### Left Side of the TouchMix-8 Mixing Surface

Refer to – Figure 11

1. Rear Panel labels.
2. Balanced female XLR and 1/4" TRS combo inputs (1–4). The TRS connectors supply a +10dB pad.



**NOTE:** Inputs 1 & 2 may be switched to Hi-Z for use with guitars and other instruments having passive pick-up systems. See Channel 1 or 2 Setup for more information.

3. Balanced female XLR inputs (5–8).
4. Trim – Channels 1–8 adjusts input signal level prior to A/D conversion.
5. Color LCD touchscreen
6. Home – Navigates up the menu structure to the Home screen
7. Menu – Displays a choice of menu options, including Mixer Setup.
8. Record/Play – Displays recording controls and options.

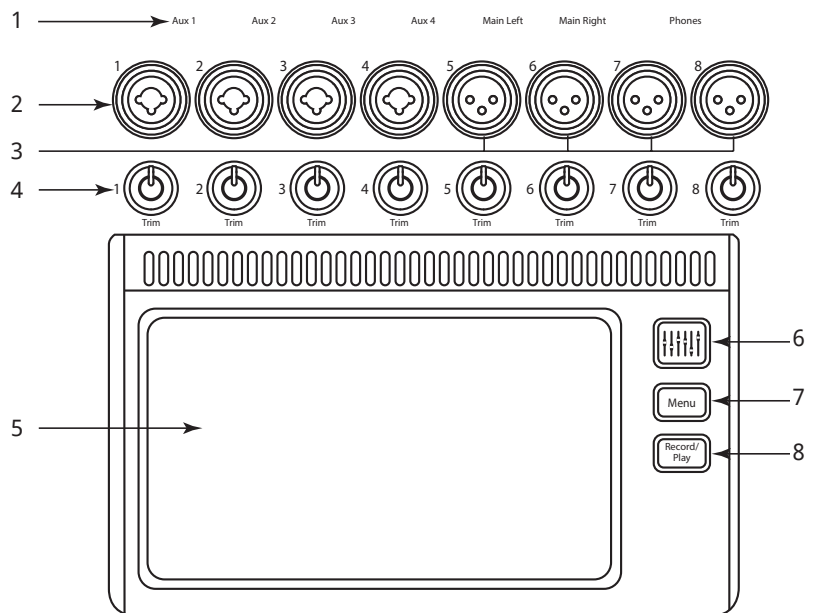

– Figure 11 –



## Right Side of the TouchMix-16 Mixing Surface

Refer to – Figure 12

1. **1/4" TRS inputs (17/18 and 19/20)**  
– Line level, stereo.
2. **1/4" TRS outputs Aux (7/8 & 9/10)**  
– For line-level / in-ear monitors.
3. **1/4" TRS output Cue** – For stereo Cue headphones.
4. **Phantom +48V** – Displays input channel Phantom Power buttons.
5. **Wizard** – Links to wizards that assist with various tasks.
6. **Auxes** – A shortcut to the Aux Mix screen.
7. **1/4" TRS output Monitor** – For stereo control-room loudspeakers.
8. **Power (Standby)** – Takes the mixer in and out of Standby.



**IMPORTANT:** Before removing power (unplugging) press the **Standby** button to power-down the mixer.

9. **Info** – Displays the menu of help topics.
10. **Mute Groups** – Displays Mute Group controls and setup options.
11. **FX Mute** – Mutes all four FX outputs.
12. **Phones Level** – Displays Phones level control, use Master Control to adjust.
13. **Talk** – Enables the Talkback microphone - press/hold to talk.
14. **Monitor Level** – Displays Monitor level, use Master Control to adjust.
15. **U1** – User Button – Factory default selects the next control to the left.
16. **U2** – User Button – Factory default clears all clipping indications.
17. **Ø** – Returns the selected control to its default position.
18. **U3** – User Button – Factory default clears all Cues.
19. **U4** – User Button – Factory default selects the next control to the right.



**NOTE:** Refer to [MIDI Setup on page 57](#) to re-assign the User Buttons.

20. **Master Control** – Adjusts the selected parameter, press & turn for fine adjustments.

## TouchMix-16

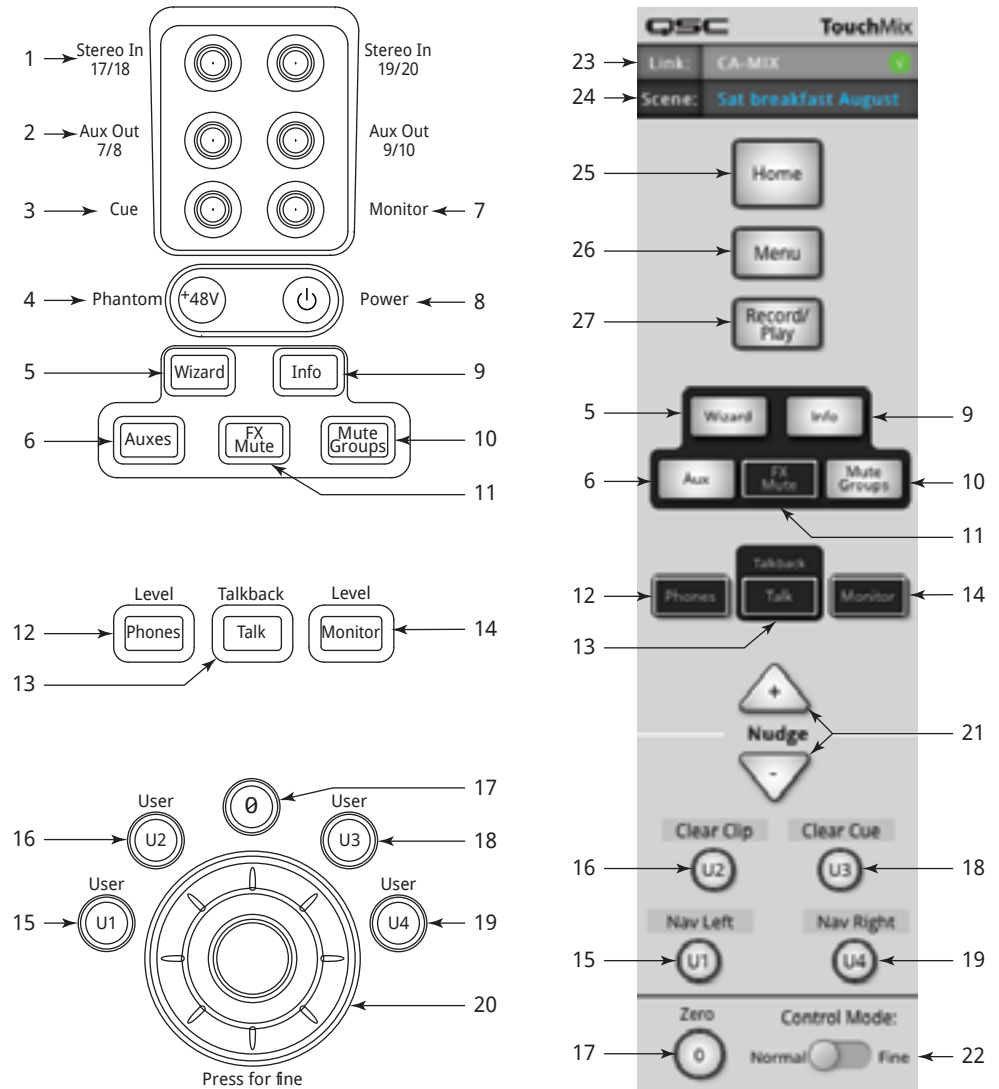

– Figure 12 –

21. **Nudge (+/-)** – Increases or decreases the value setting of the currently selected parameter.
22. **Control Mode** – Changes the granularity of the Nudge control.
23. **Link** – Displays the Link status and Network Name if connected.
24. **Scene** – Displays the name of the current Scene.
25. **Home** – Navigates up the menu structure to the Home screen.
26. **Menu** – Displays a choice of menu options, including Mixer Setup.
27. **Record/Play** – Displays recording controls and options.

## Right Side of the TouchMix-8 Mixing Surface

Refer to – Figure 13

1. **1/4" TRS inputs (9/10 and 11/12)** – Line level, stereo.
2. **Phantom +48V** – Displays input channel Phantom Power buttons.
3. **Auxes** – A shortcut to the Aux Mix screen.
4. **Wizard** – Links to wizards that assist with various tasks.
5. **Phones** – Displays Phones level control, use Master Control to adjust.
6. **U2** – Factory default clears all clipping indications.
7. **U1** – Factory default selects the next control to the left.
8. **Master Control** – Adjusts the selected parameter, press & turn for fine adjustments.
9. **Power (Standby)** – Takes the mixer in and out of Standby.



**IMPORTANT:** Before removing power (unplugging) press the **Standby** button to power-down the mixer.

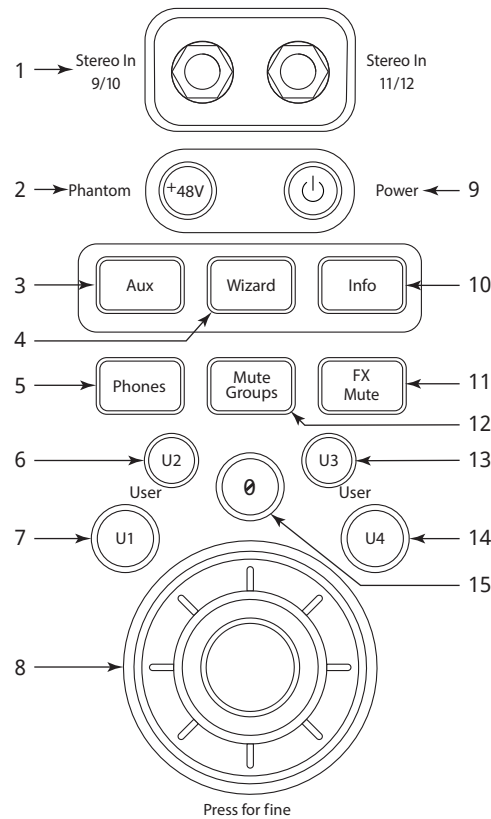

TouchMix-8

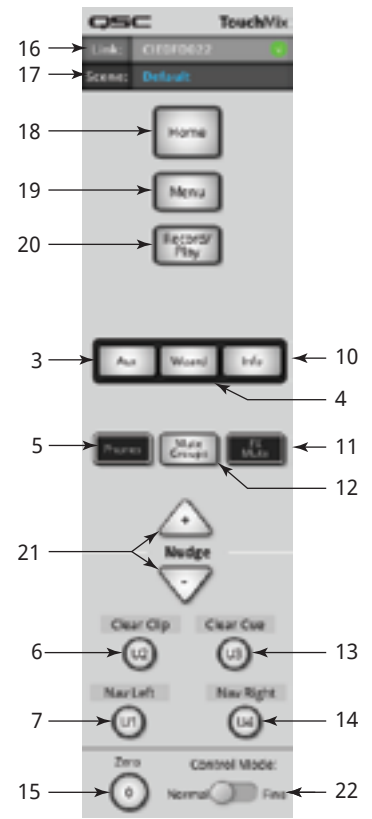

10. **Info** – Displays the menu of help topics.
11. **FX Mute** – Mutes all four FX outputs.
12. **Mute Groups** – Displays Mute Group controls and setup options.
13. **U3** – Factory default clears all Cues.
14. **U4** – Factory default selects the next control to the right.
15. **0** – Returns the selected control to its default position.
16. **Link** – Displays the Link status and Network Name if connected.
17. **Scene** – Displays the name of the current Scene.
18. **Home** – Navigates up the menu structure to the Home screen.
19. **Menu** – Displays a choice of menu options, including Mixer Setup.
20. **Record/Play** – Displays recording controls and options.
21. **Nudge (+/-)** – Increases or decreases the value setting of the currently selected parameter.
22. **Control Mode** – Changes the granularity of the Nudge control.

– Figure 13 –

## TouchMix-16 Back Panel

Refer to – Figure 14

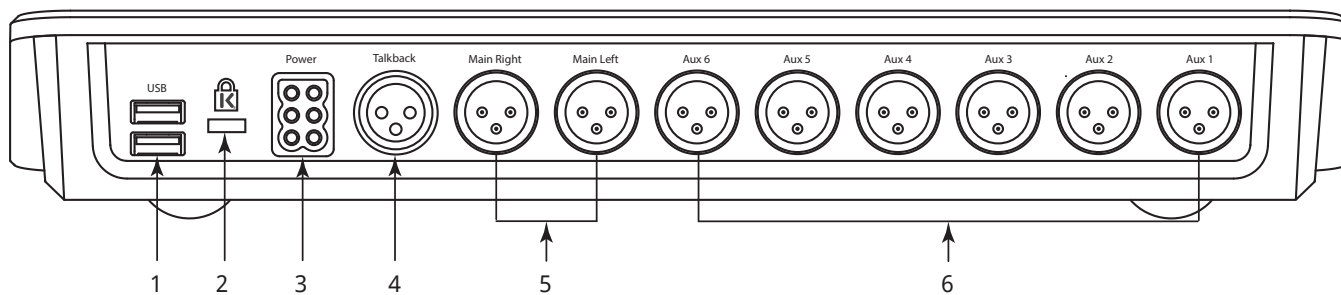

– Figure 14 –

1. **USB 3.0, Type A** – For attaching USB storage devices<sup>1</sup>, MIDI<sup>2</sup> foot switch, and Wi-Fi adapter.
2. **K & Lock® Security Slot** – Compatible with the MicroSaver Security Cable
3. **Power Supply** – Use the power supply delivered with the mixer, do not substitute.
4. **Talkback microphone** – Balanced female XLR
5. **Main Right and Left output** – Balanced male XLRs
6. **Auxiliary outputs 1 through 6** – Balanced male XLRs

## TouchMix-8 Back Panel

Refer to – Figure 15

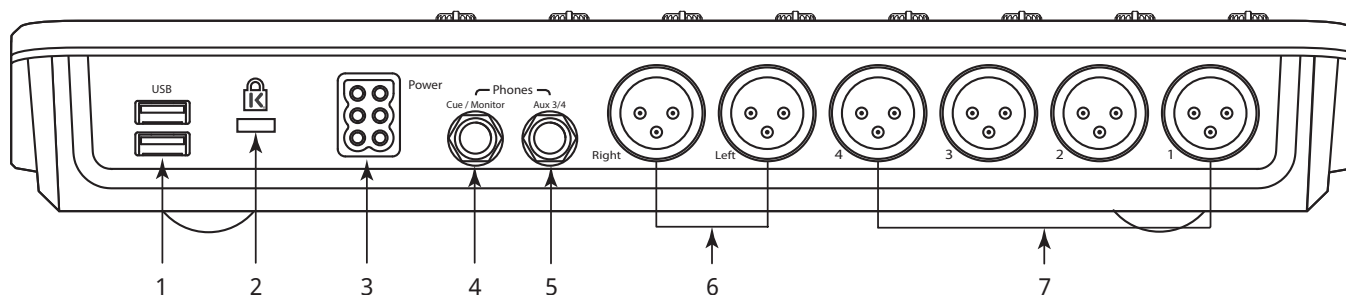

– Figure 15 –

1. **USB 3.0, Type A** – For attaching USB storage devices<sup>1</sup>, MIDI<sup>2</sup> foot switch, and Wi-Fi adapter.
2. **K & Lock® Security Slot** – Compatible with the MicroSaver Security Cable
3. **Power Supply** – Use the power supply delivered with the mixer, do not substitute.
4. **Cue / Monitor** – Stereo 1/4" TRS. Line or headphone output is directed to this output when a channel Cue is activated.
5. **Aux 3/4** – Stereo 1/4" TRS. Line or in-ear output. This output is wired in parallel with Aux 3 and 4 XLRs.
6. **Main Right and Left output** – Balanced male XLRs
7. **Auxiliary outputs 1 through 4** – Balanced male XLRs

1 Drives must be formatted using the FAT32 file system. For best results use 7200 RPM, USB 3 hard drives or high-speed SSD. Drive performance is critical for recording. For more information and to see a list of qualified drives, visit [qsc.com](http://qsc.com). At this time, the TouchMix does not support importing or re-importing digital audio files that have been created or edited on another device.

2 The TouchMix supports "class compliant" USB MIDI devices. QSC has verified proper operation with these USB MIDI footswitches: iCON G-BOARD and Logidy UMI3

## Home



There's no place like it. The Home screen displays the large faders and the navigation strip. The Home button takes you to the Home screen but also acts as a Back button in some instances. Depending on where you are in the mixer, it may be necessary to push Home twice to get to the Home screen.

## The Nav (Navigation) Strip

The Nav Strip provides a means of navigating between fader banks and an overview of all fader positions.

Refer to – Figure 16

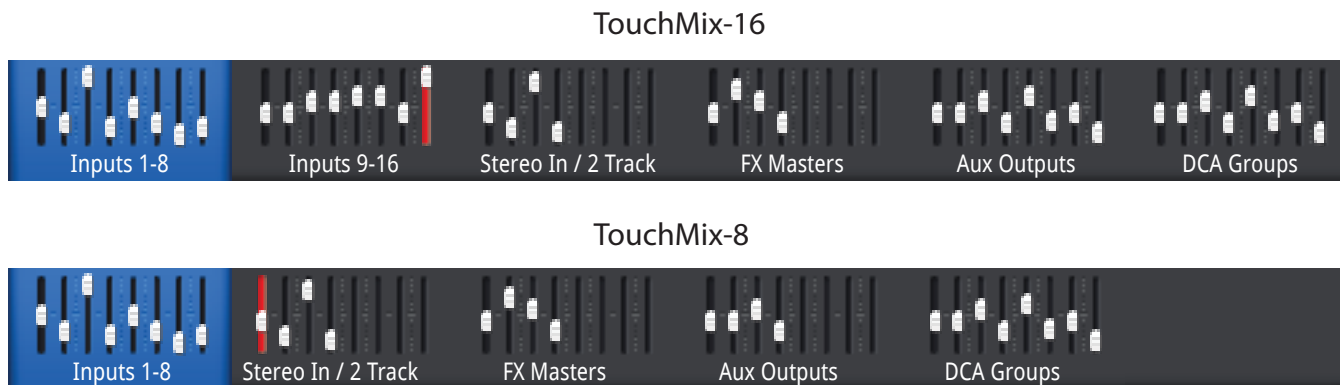

– Figure 16 –

**To access the Nav Strip** – From any screen, press Home once or twice to display Home page.

**Blue Nav Strip Bank** – Indicates the currently selected bank.

**Nav Strip Titles** – Indicates the type and range of the channels.

**Faders** – The faders represent the current position of all the mixer's faders. You cannot change the fader levels on the Nav Strip

**Red Fader Slot** – This is a "sticky" clipping indicator letting you know the channel is, or has been, clipping. Make necessary adjustments to the channel trim, then go to Menu > Mixer Setup > Clear Clip, or push the U2 button.

**Inputs 1-8 and 9-16** – Display the fader settings for main mic/line inputs. (TouchMix-8, Inputs 1-8 only)

**Stereo In/2-Track Playback** – Displays the fader settings for stereo line inputs 17/18 and 19/20 (TouchMix-8 9/10, 11/12) and for 2-track playback from USB.

**FX Masters** – Displays the level of the returns for the four internal effects processors.

**Aux Outputs** – Displays the level of the six mono and two stereo auxiliary outputs. (TouchMix-8 four mono auxiliary outputs only)

**DCA Groups** – Displays the level of the eight DCA master faders. See Misc > DCA Groups.

## Where and What Things Are on the Home Screen Channels

Refer to – Figure 17

1. **Select button** – Displays the channel name. Touch to access Master Channel controls.
2. **Pan Indicator** – Adjust in Master Channel.
3. **Channel Cue** – Routes the channel signal to the Phones and Monitor outputs.
4. **"I"** – Represents physical XLR. Channel type (In, Aux, FX, etc.) is hidden by Record/Arm indicator.
5. **Record/Arm** – Indicates channel is armed for multi-track recording.
6. **48V** – Indicates the Phantom Power is on.
7. **C** – Indicates Compressor is engaged.
8. **G** – Indicates Gate is engaged.
9. **Unity** – 0 dB (Fader)
10. **Channel/Main Fader** – Adjust by touch or Master Encoder. Yellow indicates selected.
11. **Unity** – 0 dB (Meter)
12. **Meter** (Input channel) – Indicates the pre-fader signal level.
13. **Channel color** – Blue = selected, Gray = not selected. Touch to select.
14. **Channel Mute** – Silences the channel audio to the Main L/R, Auxiliaries and FX. Does not mute send to multi-track. You can listen to a muted channel using the Cue button; the channel level meter shows the audio level.
15. **Scene** – The currently active Scene. Select from Menu > Scenes.
16. **Link** – Indicates linked adjacent channels
17. **L** – Indicates the Limiter is engaged
18. **F** – Indicates the Filter is engaged
19. **L/R Meters** – Indicate Main output signal level.
20. **Infinity** – Fader position for fully attenuated output signal.

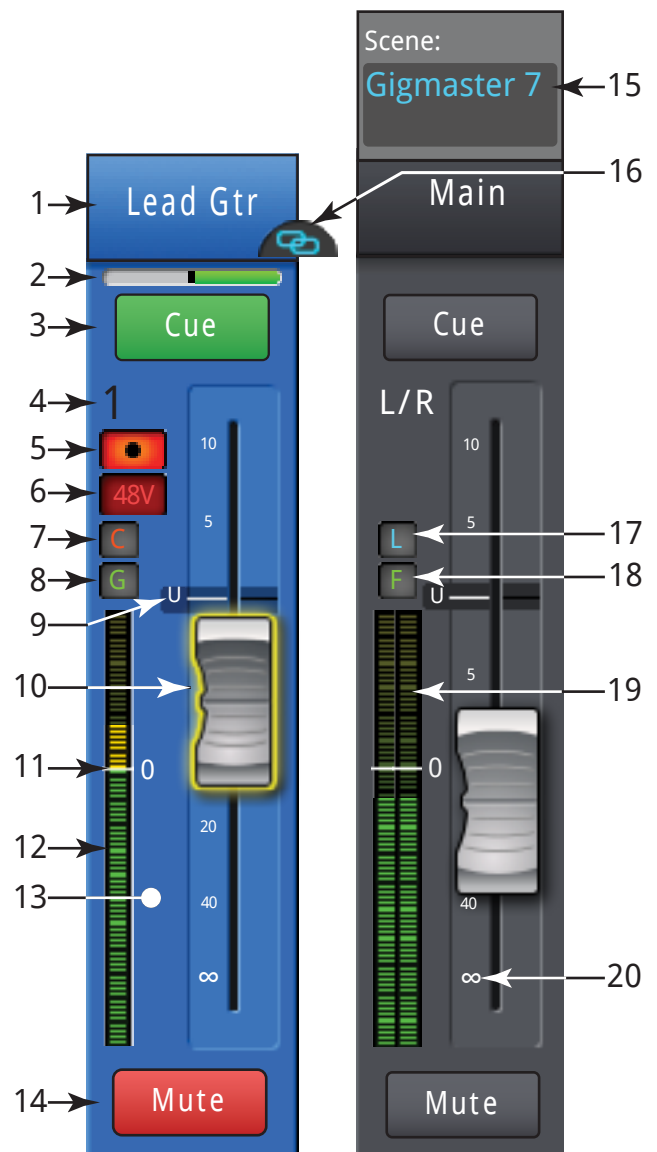

– Figure 17 –

# Input Channel

## Input Channel – Trim

The Trim (gain) control sets the level of the analog input signal just before conversion to digital. The Trim controls are not available on the iPad App.

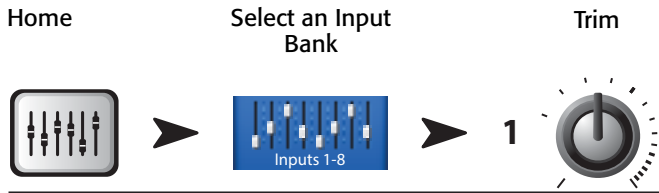

Refer to – Figure 18



**IMPORTANT:** Proper gain trim adjustment prevents clipping, improves signal-to-noise performance, and allows preset compression and gate dynamics to function as intended.

The following controls and indicators are used to set the input gain Trim:

1. **Trim Controls 1–16** (TouchMix-8 1–8) – These are mechanical controls found on the TouchMix mixing surface.
2. **Nav Strip** – Touch to select.
  - The TouchMix-16 uses the first two fader banks for input channels 1–8 and 9–16 respectively.
  - The TouchMix-8 uses the first fader bank for Input channels 1–8.
  - The red line in Inputs 1-8 fader bank is a clip indication that is persistent (sticky) until cleared. When you clear a clip indication, it is cleared only for the device (iPad or TouchMix) on which you cleared it.
3. **Input Channel Fader** – Adjusts the output of the channel to the Main L/R outputs.
4. **Level Meter** – Indicating that the signal level in the channel is below unity. If input gain trim is properly adjusted, this is what you will see when the source is playing somewhat below its average level
5. **Level Meter** – Indicating that the signal level in the channel is at unity. If input gain trim is properly adjusted, this is what you will see when the source is playing at its average level.
6. **Level Meter** – Indicating that the signal level in the channel is above unity. If input gain trim is properly adjusted, this is what you will see when the source is playing somewhat above its average level.
7. **Level Meter** – Indicating that the channel is clipping. This is an indication the mixer’s input gain or the source’s output level needs to be reduced. The meter in the Nav Strip stays red until you touch Clear Clip (on the Menu screen) or press User button U2.

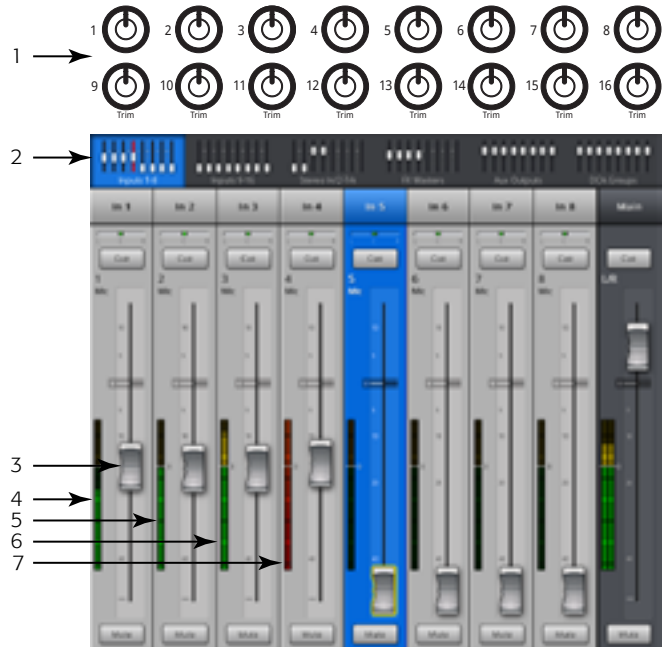

– Figure 18 –

## Input Channel – EQ

Controls and displays the settings for Input Channel equalization.

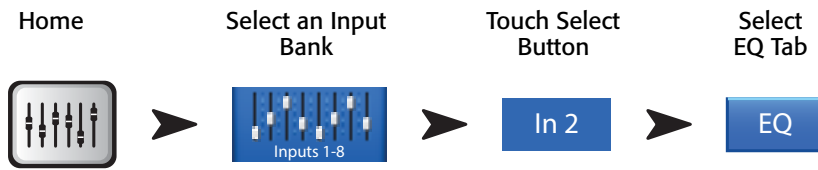

Refer to – Figure 19 –

1. **EQ Tab** – Selects the EQ screen.
2. **Parametric EQ Graph** – A graphic representation of the equalization curve based on the EQ settings. When the EQ is engaged, the trace changes from black to white.
  - **EQ Graph Vertical Scale** – Represents audio level from -20 dB to +20 dB.
  - **EQ Graph Horizontal Scale** – Represents frequency from 20 Hz to 20 kHz.
3. **Low and High Cut Filter Buttons** – These filters cut frequencies below or above the frequency set by the corresponding Freq control.
4. **Low and High Shelf Filter Buttons** – Changes EQ Band 1 and Band 4 from parametric filters to shelving filters. When a shelf filter is engaged, the Bandwidth control is not available.
5. **Frequency Bands 1, 2, 3, and 4 Buttons** – Engages / disengages the associated parametric EQ band. Four overlapping frequency ranges, each adjustable from 20 Hz to 20 kHz. Each band has an associated Gain, Frequency, and Bandwidth control.
6. **Freq Control Knob** (Low and High Cut) – Sets the frequency of the low and/or high cut filter as measured from a point 3 dB below 0 or unity.
7. **EQ In Button** – Engages the equalizer.
8. **Gain Control Knob** – Adjusts the gain at the frequency setting of the associated EQ band. Range of -15 dB to +15 dB.
9. **Freq Control Knob** (Frequency bands 1 – 4) – Sets the center frequency of the associated EQ band. If the Shelving filter is engaged, the Freq control sets the frequency of the shelf filter at a point 3 dB above or below 0 or unity.
10. **Bandwidth Knob** – Adjusts the bandwidth of the associated EQ band. The Bandwidth is measured in Q. When the Self Filter is engaged, the Bandwidth knob is hidden.
11. **Simple Button** – Hides the Low Cut, High Cut, Frequency, and BW controls. Does not effect existing settings.
12. **Reset Button** – Sets all the EQ controls to their factory default position.
13. **Prev / Next Buttons** – Navigates to the next or previous channel. The buttons cycle through the Input, playback, record, and FX channels, then loops back to Input 1. If you start in the Auxes, the buttons cycle through the Auxiliary outputs and the Main L/R channels.

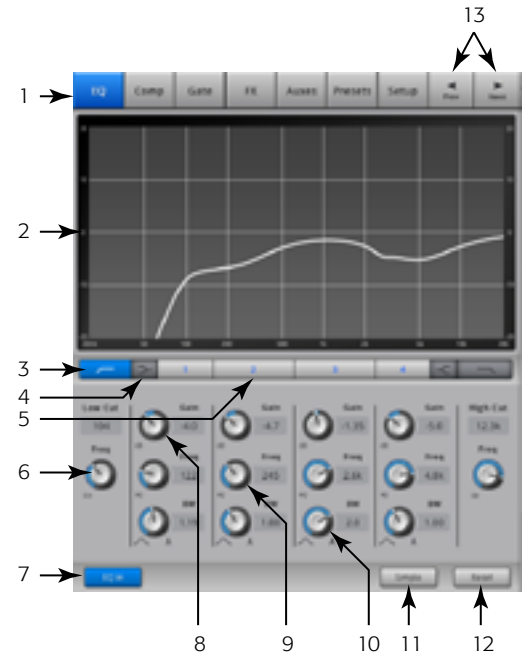

– Figure 19 –

## Input Channel – Compressor

The Compressor controls the dynamic range of a signal above a set Threshold.

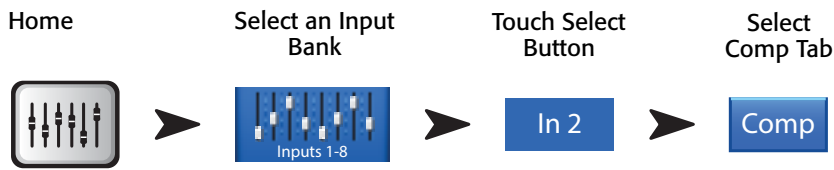

Refer to – Figure 20 –

1. **Comp Tab** – Selects the Compressor screen.
2. **In** – RMS input level
3. **Out** – Output level after any applied compression
4. **GR** – Gain Reduction – (red) indicates how much the signal is being reduced by the compressor.
5. **Threshold Slider** – Sets the point at which the compressor will begin to reduce signal level.
6. **Compressor Graph** – When the Compressor is engaged, the trace changes to yellow.
  - **Vertical Scale** – From 0 dB to -60 dB
  - **Threshold** (E)
  - **Ratio** (B to E)
  - **Attack time** (A to C)
  - **Release time** (C to D).
7. **Attack Slider** – Adjusts how quickly the compressor reacts to a signal that exceeds the threshold.
8. **De-Esser Knob** – Adjusts the amount of compression at the frequencies of sibilant consonants such as “s”, “z”, and “sh”.
9. **Comp In Button** – Engages and disengages the compressor.
10. **De-Esser Button** – Engages or disengages the De-Esser.
11. **Release Slider** – Adjusts how quickly the compressor stops compressing when signal falls below threshold.
12. **Knee In Button** – The knee determines whether the compressor comes on abruptly (not engaged) or gradually (engaged) as the threshold is crossed.
13. **Gain Knob** – Adjusts the overall output gain to makeup any loss after the signal is compressed.
14. **Simple Button** – Turns Simple mode on and off. Hides all controls except:
  - Comp In button
  - Simple button
  - Reset button
  - Compression knob
15. **Reset Button** – Sets all the Comp controls to their factory default position.
16. **Ratio Slider** – Sets the ratio of input level to output level when the signal exceeds the threshold.

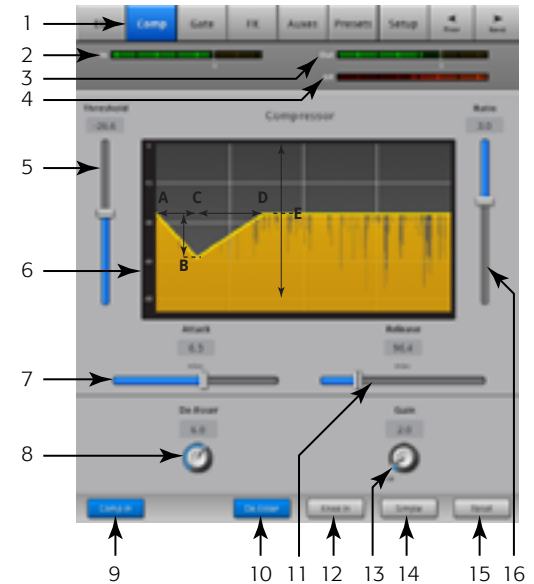

– Figure 20 –



## Input Channel – Gate

The Gate passes audio above a set Threshold, and attenuates or silences audio below the Threshold.

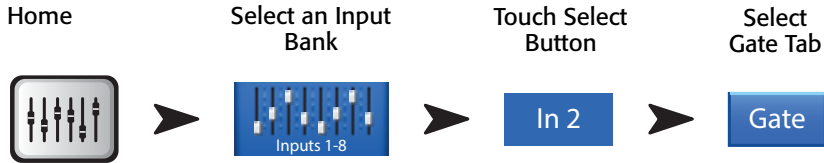

Refer to – Figure 21 –

1. **Gate Tab** – Selects the Gate Screen.
2. **In** – RMS input level
3. **Out** – Output level
4. **GR** – Gain Reduction – indicates how much the signal is being reduced by the Gate.
5. **Threshold Slider** – Sets the point at which the Gate allows audio to pass.
6. **Gate Graph** – When the Gate is engaged, the trace turns green.
  - Threshold (A)
  - Attack time (A-B)
  - Release time (C-D)
  - Attenuation Level (E).
7. **Attack Slider** – Adjusts how quickly the gate reacts to a signal that exceeds the threshold.
8. **Gate In Button** – Engages or disengages the Gate.
9. **Hold Knob** – Sets the minimum time the Gate stays open once it is opened, and the length of time the Gate stays open after the input level drops below the Threshold.
10. **Release Slider** – Adjusts how quickly the Gate attenuates the audio when signal falls below threshold.
11. **Simple Button** – Turns Simple mode on and off. Hides all controls except:
  - Gate In button
  - Simple button
  - Reset button
  - Gating knob
12. **Reset Button** – Sets all the Gate controls to their factory default position.
13. **Attenuation Slider** – Sets the amount of attenuation applied to the output when the signal is below the Threshold.

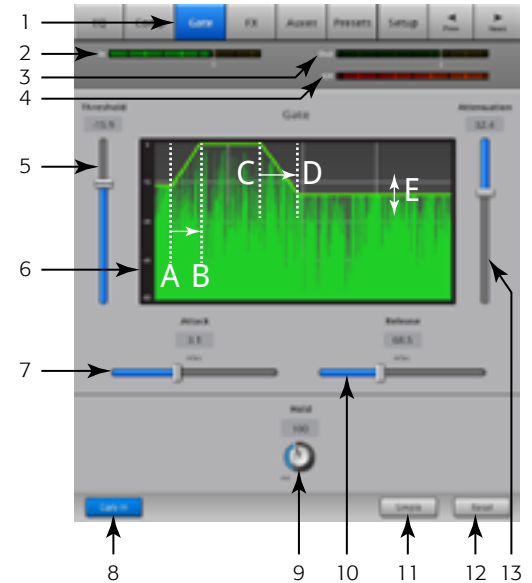

– Figure 21 –

## Input Channel – FX Sends

Controls how much of the Input channel's audio is sent to the FX devices. In addition, you can adjust the FX Sends at *Menu > FX Overview*.



Refer to – Figure 22 –

1. **FX Tab** – Selects the FX Sends screen.
2. **FX Send Sliders** – Sets the level of audio “sent” from the channel to the FX mix; -40 dB is off.
3. **FX Processor** – The thumbnail representation of the FX processor takes you to a screen where you can select the processor for that FX mix.
4. **Simple FX** – Hides the Global FX Parameters for a simpler setup.
5. **Global FX Parameters** – Provides control over the two most important parameters of the selected FX device. The controls are different depending on the selected processor. For detail on these and other FX controls, refer to the FX device topic.
6. **Pitch Correct** – Refer to [Input Channel – Pitch Correct on page 35](#).

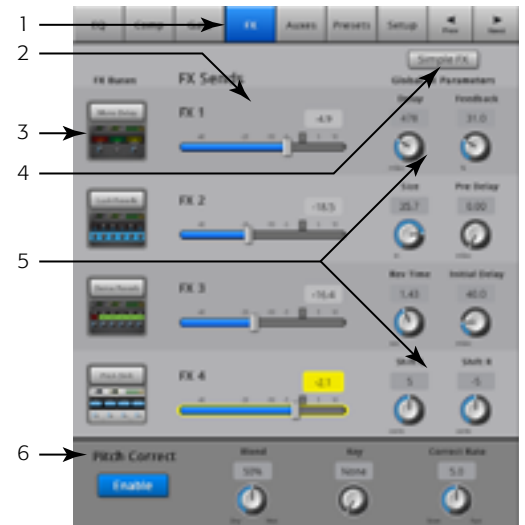

– Figure 22 –

## FX Signal Flow

Audio input passes through the EQ, Dynamics (compressor and gate) and the Channel Fader. At this point the audio signal is split and goes in two directions:

1. Through the Pan control to the Main L/R Fader and Main outputs.
2. To the 4 Channel FX sends (– Figure 23 shows just one of the four FX Sends)

The FX Send control determines how much of the channel audio is sent (or routed) to the assigned FX processor.

The FX processor works its magic on the audio and transforms the mono input into a stereo signal. The FX Master fader controls how much or how little of the processed (“wet”) signal is combined with the unprocessed (“dry”) before going to the FX Master fader and on to the Main L/R outputs.

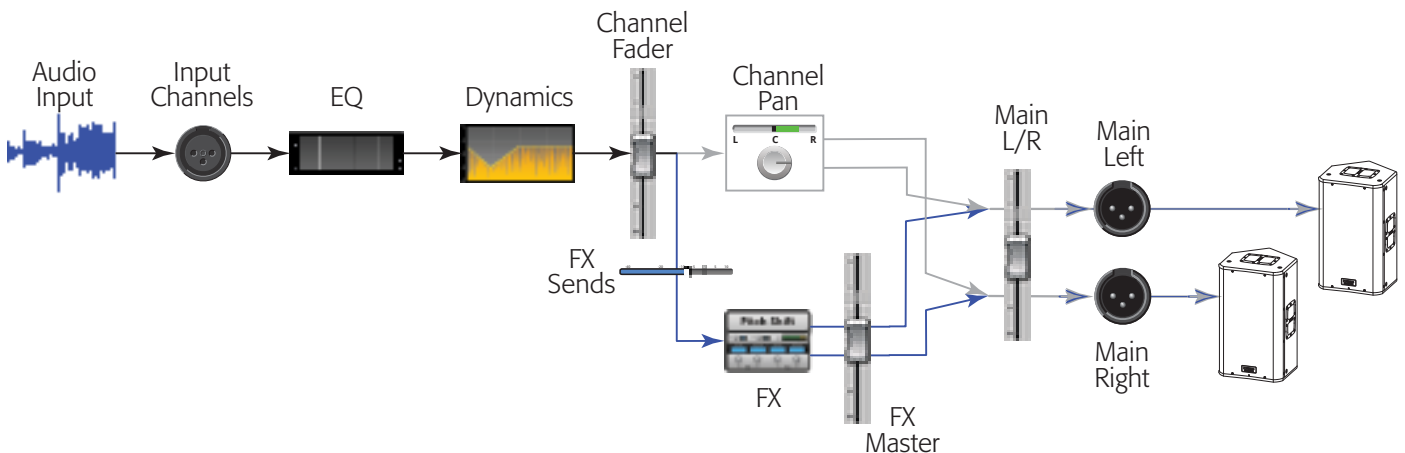

– Figure 23 –

## Input Channel – Pitch Correct

Pitch Correct (available on Input channels 1 through 16) shifts the frequency of an input signal to match the nearest “correct” musical pitch. The mixer has only one Pitch Corrector which can be assigned to only one channel at a time.



**IMPORTANT:** You can enable or disable the Pitch-Correct feature using User Buttons without regards to the position of the Enable button on this screen. If you don’t hear any difference with Pitch Correct enabled, check to make sure the feature has not been disabled using the User Button feature. Refer to [MIDI Setup on page 57](#).



Refer to – Figure 24

1. **Pitch Correct Enable Button** – Assigns and enables/disables Pitch Correct to the currently selected channel.
2. **Blend Knob** – Sets the ratio of uncorrected (Dry) to corrected (Wet) signal. When fully clockwise, only corrected signal will be heard. When fully counter clockwise, only the original signal will be heard. Intermediate settings will result in a doubling effect.
3. **Key Knob** – Selects a key for the pitch corrector to use in determining what the target note is. If “None” is selected, the Pitch Corrector will target the nearest chromatic pitch. The table shows the Key selections.
4. **Correct Rate Knob** – determines how quickly the pitch is corrected

None	E	A
C	F	A#/Bb
C#/Db	F#/Gb	B
D	G	
D#/Eb	G#/Ab	

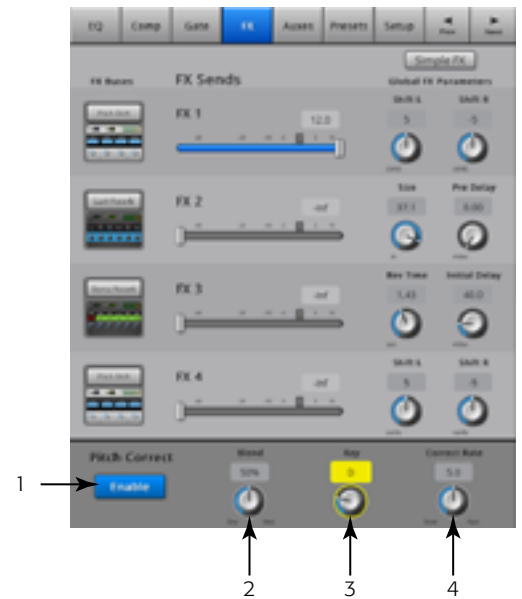

– Figure 24 –

## Input Channel – Aux Sends

Auxiliary outputs are used to create a mix for stage monitors, in ear monitors, remote speakers or video / broadcast. For the TouchMix-16, there are six (1-6) mono and two (7/8 – 9/10) stereo Aux mixes. For the TouchMix-8 there are four (1-4) mono Aux mixes.

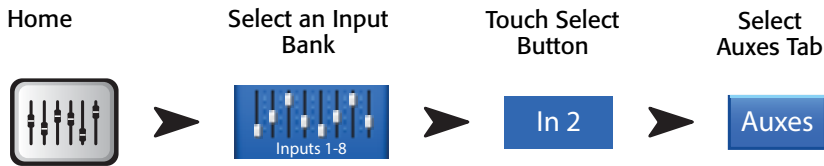

Refer to – Figure 25

1. **Auxes Tab** – Selects the Aux Sends screen
2. **Overview Button** – Navigates to the Aux Overview where you can see and adjust all Aux Sends at one time
3. **Aux Master Buttons** – Touch one of the Aux Master buttons to go to the associated Aux output controls.
4. **Aux Send Sliders** – The Aux Send sets the level of audio sent from the channel to the Aux output; -40 dB (-Inf) is off.
5. **Pre Fdr/ Post Fdr / Pre Dyn / Pre All Button** – Takes you to the Aux Output channel where you can change the setting. This setting is for all Aux Sends to the selected Aux Output. Determines where in the signal flow the aux signal is taken. Refer to – Figure 26
6. **Aux Sends Pan Slider** – Aux mixes (7/8 & 9/10 for TouchMix-16, only) always have a pan control. When two auxes are linked, the even aux's send control becomes a pan control. Refer to the Aux Output topic for Aux Linking information.
7. **Aux Link Indicator** – Indicates the Aux channels are linked. The TouchMix-16, auxes 7/8 and 9/10 cannot be unlinked. You can link Aux channels from an Input channel Aux Sends screen by touching one of the Aux Master buttons, or one of the pick-off buttons. Both take you to the Aux channel Setup screen where linking is accomplished.

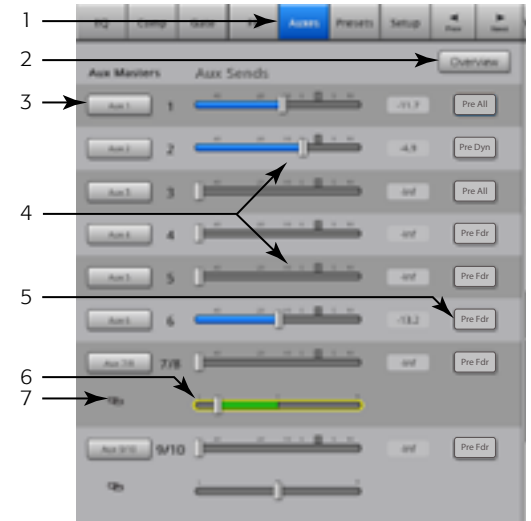

– Figure 25 –

## Auxiliary Channels Flow Diagram

The Pre All, Pre Dyn, Pre Fader, and Post Fader buttons are radio-buttons that provide options for where the Aux Outputs get their signal. In – Figure 26 the Pre Fader button is selected.

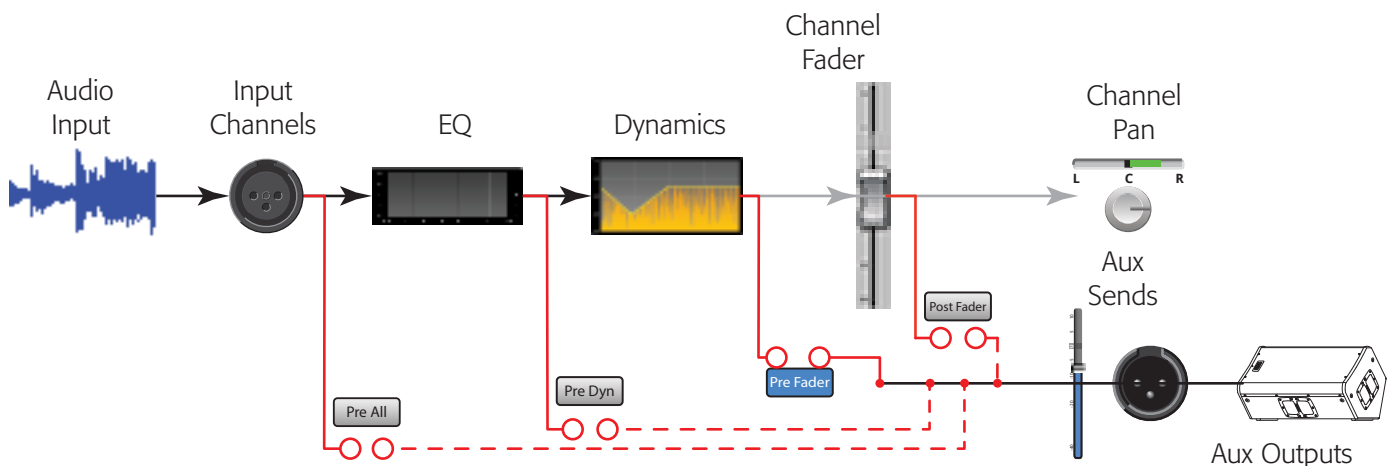

– Figure 26 –

## Input Channel – Presets

Select, recall and store channel settings.

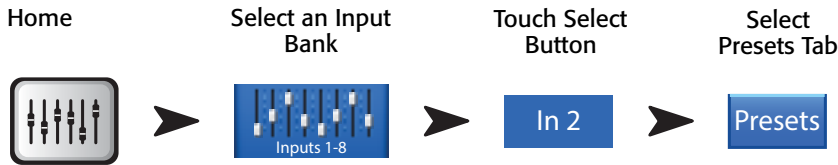

Refer to – Figure 27 and – Figure 28

1. **Presets Tab** – Selects Presets screen.
2. **Current Preset** – The current preset.
3. **Preset Info Button** (Factory only) – After selecting the Instrument, Type, and Preset, press this button to see more information about the preset. Information provided varies and may include style of music, instrument details, microphone/pick-up type and position, or other helpful information. This button provides information only, it does not change anything.
4. **Factory / User Switch** – Toggles between Factory and User presets.
  - Factory Presets – A library of QSC designed input-channel presets.
  - User Presets – User Presets may be stored to and recalled from Internal memory or an External (USB) storage device.
5. **Instrument List** (Factory only) – Displays a list of instrument categories. For example, Drums, Strings etc. Select the instrument assigned to this channel.
6. **Type List** (Factory only) – Displays a list of instruments within the Instrument category you selected. Select one.
7. **Preset Name List** (Factory only) – Displays a list of factory-designed presets, select one.
8. **Recall Preset Button** – Recalls the selected Preset. Recalls all parameters for an Input Channel except:
  - Analog/Multi-track state
  - Track/Arm button
  - Cue
  - Mute
  - Channel Link state
9. **Omit Levels Switch** – When engaged, Channel Faders, FX Sends, and Aux Sends are not recalled.
10. **Omit Name Switch** – When engaged, preset Channel Names are not recalled.
11. **Omit Phantom Switch** – When engaged, Phantom power “On” setting is not recalled.
12. **Save / Save As Button** (User only) – Displays a page with options for naming a preset and selecting internal or USB storage destination.
13. **Internal List** (User only) – Displays a list of user-defined presets that are saved on the mixer.
14. **External (USB) List** (User only) – Displays a list of user-defined presets that are saved on a USB drive currently connected to the mixer.
15. **Copy to USB Button** (User only) – Copy the selected Internal preset to a USB drive connected to the mixer. Cannot copy to Factory or to the same location as the selected file.
16. **Copy to Internal Button** (User only) – Copy the selected USB preset to the Internal Mixer storage. Cannot copy to Factory or to the same location as the selected file.
17. **Delete Button** (User only) – Select a User Preset and touch this button to delete the Preset.

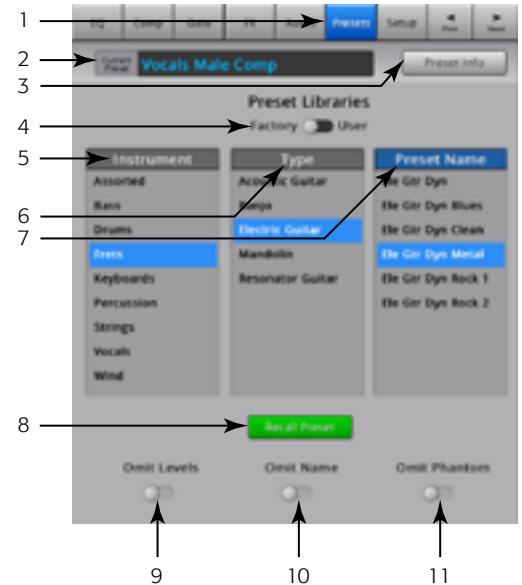

– Figure 27 –

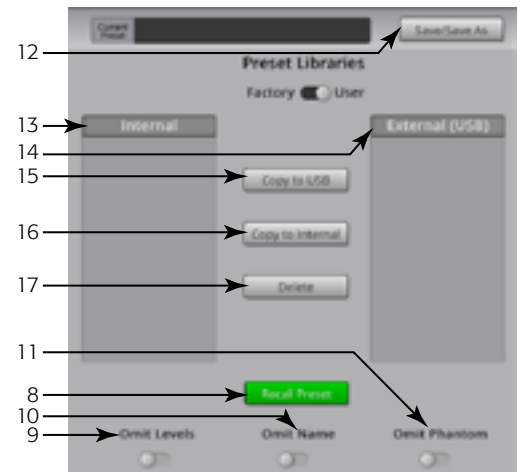

– Figure 28 –

18. **Save Button** – After pressing Save/Save As, the Save Preset As screen displays. The save button saves the currently active preset to the location selected, and with the name displayed on this screen.

19. **Enter Name Field** – You can do one of the following:



**IMPORTANT:** Presets and Scenes are saved as files, so naming restrictions are more strict than other names such as a channel name. When saving a preset using the keyboard displayed on the TouchMix, the restricted characters are not available. The iPad keyboard is not restricted. You can name a Scene or Preset using characters 1 to 0, A to Z, a to z, a period (.), hyphen (-), equal sign (=), exclamation point (!), parenthesis, underscore (\_), or plus sign (+).



– Figure 29 –

- Choose to keep the same name. If the name exists in Internal or USB preset, and you are saving to the same location, you are asked if you want to overwrite the name. If the name does not exist, the presets saves to the selected location.
- You can change the name partially or in whole. If the name does not exist in the selected location, the preset saves.

20. **Save Location Switch** – Select either Internal or External (USB).

## Input Channel – Setup

Channel Setup provides control of various functions that apply specifically to a single channel.

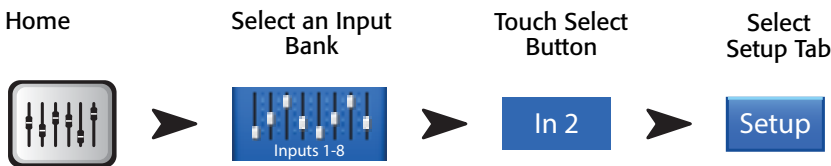

Refer to – Figure 30

- Setup** – Selects the Setup screen
- Link** – Links adjacent channels. The odd numbered channel settings are copied to the even numbered channel. Pan settings are mirrored. Only odd > even pairings are supported – even > odd pairings are not.
- Channel** – The system channel number. This does not change.
- Name** – Touch the Name to display a keyboard that may be used to enter a name for the channel.
- Input Selector** – (TouchMix-8. Mic Inputs 1-2 only) Line accepts line-level inputs, Hi-Z is for use with guitars and other instruments having passive pick-up systems.
- Source** – Selects the corresponding Analog input or multi-track (Track) as the audio source for the channel.
- Polarity** – Touch to change polarity of the channel output.
- Digital Gain** – Digital Gain may be added when a source has insufficient output level to adequately drive an input channel. Stereo Input channels 17/18 and 19/20 (TouchMix-16,) and 9/10 and 11/12 (TouchMix-8) do not have a mechanical gain control, only Digital Gain.
- Arm to Record** – Sets the channel to be included in a multi-track recording.
- Mic Phantom** – Turns 48V phantom power on/off for the channel.
- Assign To** – Turns the channel's assignment to the Main Left / Right output on and off. Useful for applications such as 5.1 playback or live performance to a click track. The factory default is on – assigned to Main L/R.
- Mute Group Assignment** – Select the Mute Groups this channel is to be part of. User-assigned names display on the buttons. See the Mute Groups topic.
- DCA Group Assignment** – Select the DCA Groups this channel is to be part of. User-assigned names display on the buttons. See the DCA Groups topic.

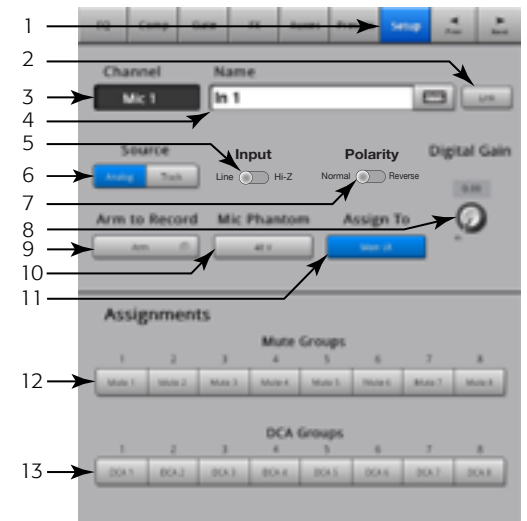

– Figure 30 –

# Output Channel

## Output Channel – EQ

The Main LR and Aux 1 – 6 (Aux 1 – 4 TouchMix-8) outputs have a 1/3 octave graphic EQ. Stereo auxes 7/8 and 9/10 use a parametric EQ identical to the input channel's EQ.

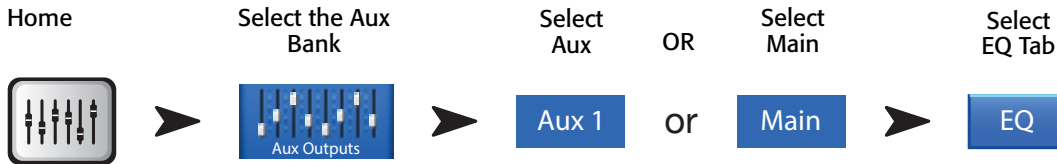

Refer to – Figure 31 and – Figure 32 (iPad Screens)

1. **EQ Tab** – Selects the EQ screen

### For Aux 1-6 (1-4 TouchMix-8) and Main L/R

2. **Band Selector Buttons** – Touch a band to access faders.
3. **GEQ Graph** – Graphic representation of the equalizer settings. The currently selected group of frequencies has a blue background.
4. **Center Frequency Labels** – Center frequency of a frequency band.
5. **EQ Faders** – Adjusts the audio level at the indicated frequency. Yellow background indicates the fader is selected.

### For all Output Channels

6. **Reset Button** – Sets all EQ controls to factory default.
7. **EQ In Button** – Engages the Graphic or Parametric EQ.

### For Aux 7/8 & 9/10 (TouchMix-16, only)

8. **Parametric EQ Graph** – A graphic representation of the equalization curve based on the EQ settings. When the EQ is engaged, the trace changes from black to white.
  - **Vertical Scale** – Represents audio level from 20 to +20 dB.
  - **Horizontal Scale** – Represents frequency from 20 Hz to 20 kHz.
9. **Low and High Cut Buttons** – Engages/disengages the filters. These filters cut frequencies below or above the frequency set by the corresponding Freq control.
10. **Low and High Shelf Buttons** – Toggles EQ Bands 1 and 4 between parametric and shelving filters. When a shelf filter is engaged, the Bandwidth control is not available.
11. **Frequency Bands 1, 2, 3, and 4 Buttons** – Engages / disengages the associated parametric EQ band. Four overlapping frequency ranges, each adjustable from 20 Hz to 20 kHz. Each band has an associated Gain, Frequency, and Bandwidth control.
12. **Freq Control Knobs** (Low and High Cut) – Sets the frequency of the low and/or high cut filter as measured from a point 3 dB below 0 or unity.
13. **Gain Control Knobs** – Adjusts the gain at the frequency setting of the associated EQ band. Range of -15 dB to +15 dB.
14. **Freq Control Knobs** (Frequency bands 1 – 4) – Sets the center frequency of the associated EQ band. If the Shelving filter is engaged, the Freq control sets the frequency of the shelf filter at a point 3 dB above or below 0 or unity.
15. **Bandwidth Knobs** – Adjusts the bandwidth of the associated EQ band. The Bandwidth is measured in Q.
16. **Simple Button** – Hides the Low Cut, High Cut, Frequency, and BW controls. Does not effect existing settings.

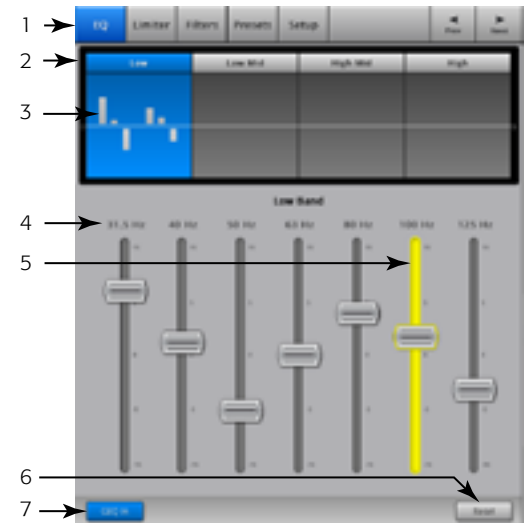

– Figure 31 –

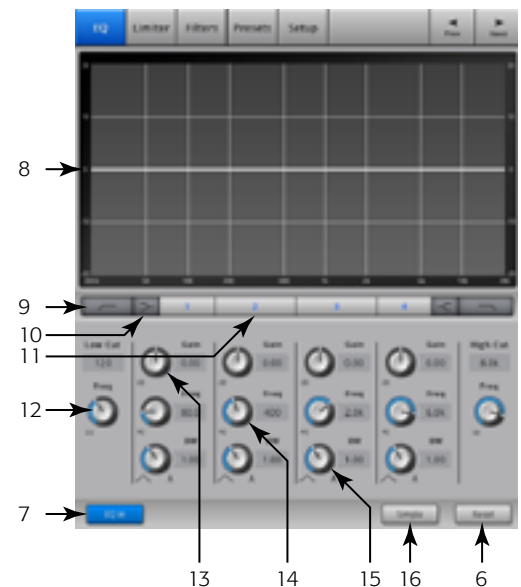

– Figure 32 –

## Output Channel – Limiter

The Limiter keeps the audio level from going above the set Threshold.

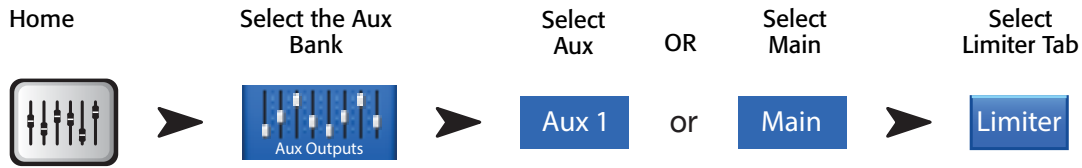

Refer to – Figure 33

1. **Limiter Tab** – Selects the Limiter screen
2. **In** – RMS input level
3. **Out** – Output level
4. **GR** – Gain Reduction – indicates how much the signal is being reduced by the Limiter.
5. **Limiter Graph** – When the Limiter is engaged, the trace is blue.
  - Threshold (A)
  - Ratio (B)
  - Attack time (A to B)
  - Release time (B to C)
  - Vertical scale = dB
6. **Threshold Slider** – Sets the point at which the Limiter will begin to reduce signal level.
7. **Ratio Slider** – Sets the ratio of input level to output level when the signal exceeds the threshold.
8. **Attack Slider** – Adjusts how quickly the Limiter reacts to a signal that exceeds the threshold.
9. **Release Slider** – Adjusts how quickly the Limiter stops Limiting when signal falls below the Threshold.
10. **Limiter In Button** – Engages or disengages the limiter.
11. **Knee In Button** – Engages or disengages the Knee. The Knee provides a smoother transition from the Attack to the Release. – Figure 33 shows the knee engaged.
12. **Simple Button** – Turns the Simple mode on and off. Hides all controls except:
  - Limiter In button
  - Simple button
  - Reset button
  - Limiting (Threshold) knob
13. **Reset Button** – Sets all the Limiter controls to their factory default position.

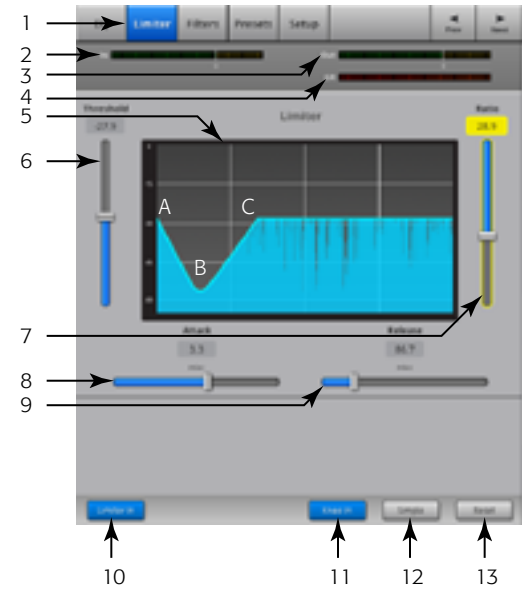

– Figure 33 –



## Output Channel – Filter

Available on the Main L/R and Aux 1 – 6 (TouchMix-16,) and 1 – 4 (TouchMix-8) outputs. These narrow, cut-only, filters are useful for dealing with feedback.

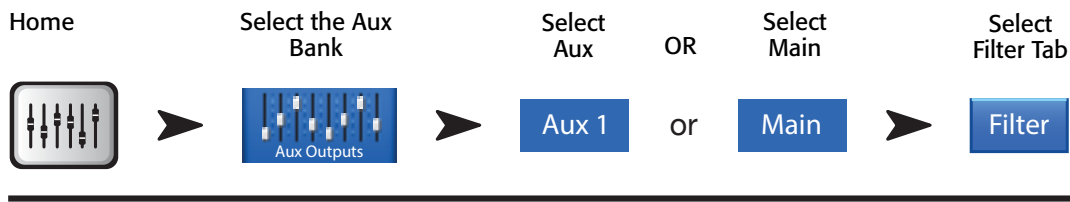

Refer to – Figure 34

1. **Filters Tab** – Selects the Filters screen
2. **Filter In Buttons** – Engages a single Filter.
3. **Lo Cut** – Attenuates, or “cuts” frequencies below this frequency setting. Range is 20 Hz to 2 kHz. The slope of this filter is 18 dB/octave.
4. **Graph** – Graphic representation of engaged filters.
  - Vertical scale = dB
  - Horizontal scale = frequency
5. **Hi Cut** – Attenuates, or “cuts” frequencies above this frequency setting. Range is 200 Hz to 20 kHz. The slope of this filter is 18 dB/octave.
6. **Freq Knob** – Sets the center frequency of a filter.
7. **Cut Knob** – Sets amount of Cut (or attenuation) for a notch filter.



**NOTE:** Aux Outputs 7/8 & 9/10 have only low- and high-cut filters. (TouchMix-16, only)

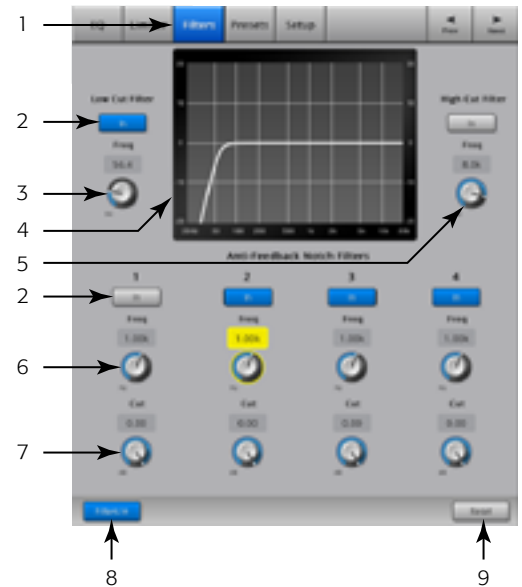

– Figure 34 –

8. **Filters In Button** – Enables / disables individual filter engagement.
9. **Reset Button** – Sets all the Filter controls to their factory default position.

## Output Channel – Presets

Store, recall and copy the settings associated with an output channel.



Refer to – Figure 35

1. **Presets Tab** – Selects the Presets screen
2. **Current Preset Label** – Displays the name of the current active preset.
3. **Save / Save As Buttons** – Displays a page with options for naming a preset and selecting internal or USB storage destination.
4. **Internal Presets List** – Up to 100 Internal Presets may be stored to and recalled from Internal memory.
5. **Factory Presets List** – Displays a list of factory programmed presets. Currently, the only preset available is *Reset*. Reset sets all output channel's parameters to their factory default state.
6. **External Presets List** – Up to 100 External Presets may be stored to and recalled from an External (USB) storage device
7. **Recall Preset Button** – Recalls stored output channel EQ settings, limiter settings, filter settings, mute assignments, DCA assignments, link state, name and (optional) channel level.
8. **Omit Levels Switch** – When set to "Omit Levels", recalling the preset will not change any levels.
9. **Copy to Internal Button** – Copy the selected Preset to the Internal Mixer storage.
10. **Copy to USB Button** – Copy the selected Preset to a connected USB drive.
11. **Delete Button** – Select a User Preset and touch this button to delete the Preset.

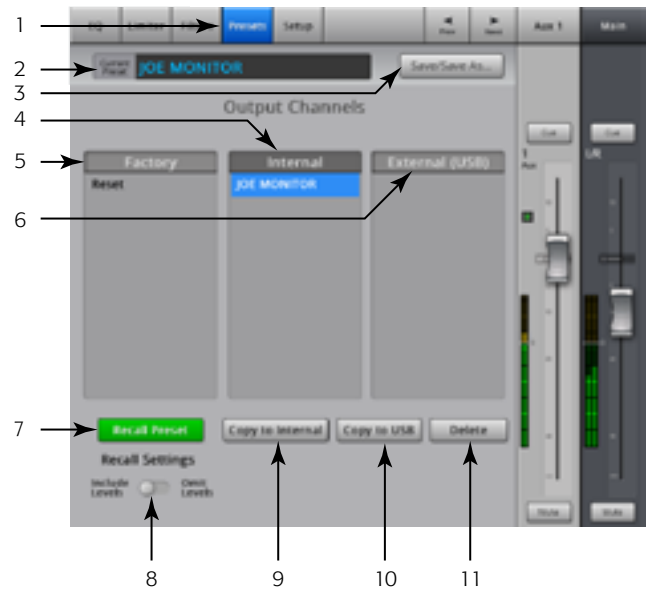

– Figure 35 –

## Output Channel – Setup / Delay

Output Channel Setup provides control of various functions that apply specifically to a single output channel.

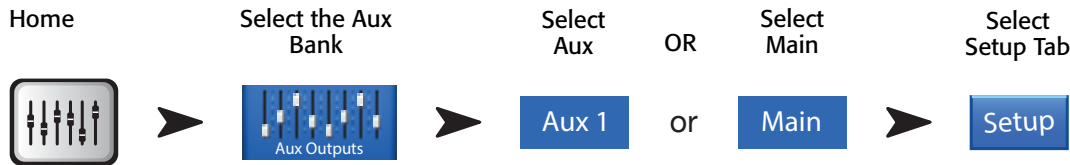

Refer to – Figure 36

1. **Setup Tab** – Selects the Setup screen
2. **Link Button** (For TouchMix-16, Aux Channels 1-6 only) (For TouchMix-8 Aux Channels 1-4 only) – Links adjacent channels. The odd numbered channel settings are copied to the even numbered channel. Pan settings are mirrored. Only odd > even linking is supported – even > odd linking is not.
3. **Channel Label** – The system name for the channel. This name does not change.
4. **Name Field** (For Aux Channels Only) – Touch the Name to display a keyboard that may be used to enter a name for the channel.
5. **Delay In Button** – Engages or disengages the Delay.
6. **GXD Amp Settings Button** – Click this button to determine the best settings for your QSC GXD amplifier. Refer to [Output Channel – QSC GXD Amplifier Settings on page 45](#) for details.
7. **Delay Knob** – Sets the output delay. Readouts are provided in milliseconds, feet, and meters.
8. **Speaker Settings Button** – Click this button to determine the best settings for your QSC K Series, KW Series, and KLA Series Loudspeakers. Refer to [Output Channel – Speaker Settings on page 44](#) for details.
9. **Assign To** – Touch this button to assign the output of this channel to the Main L/R speakers. You must set the Aux Sends on all input channels you want in this mix.
10. **Aux Pick-Off Switch** – This setting is for all Aux Sends to the selected Aux Output Channel. Determines where the aux signal is taken. The selections are: Pre Fdr/ Post Fdr / Pre Dyn / Pre All. Pre Fdr is most commonly used for monitors.
11. **Mute Group Assignment Buttons** – Select the Mute Groups this channel is to be part of. User-assigned names display on the buttons. See the Mute Groups topic.
12. **DCA Group Assignment Buttons** – Select the DCA Groups this channel is to be part of. User-assigned names display on the buttons. See the DCA Groups topic.

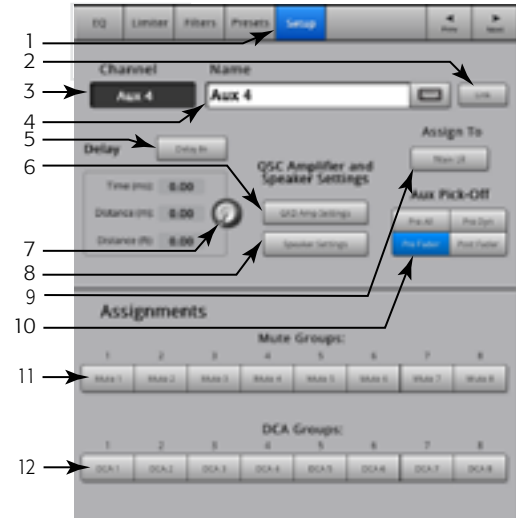

– Figure 36 –

## Output Channel – Speaker Settings

Provides help in properly adjusting QSC K, KW and KLA powered loudspeakers when used with the TouchMix.

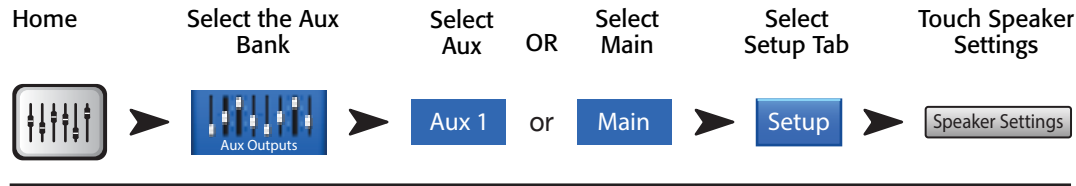

Refer to – Figure 37

1. **Select Speaker Button** – Touch the button that corresponds with the QSC K, KW or KLA speaker connected to the output.
2. **Set the Gain** – Adjust the Gain knob on your loudspeaker to the position indicated by the illustration and the text (3) below it.
3. When you are finished, touch the Done button.



**NOTE:** Subwoofer level may be adjusted to get the desired relative high/low balance.

When the speakers are adjusted as directed, signal to noise ratio is optimized and the output meters on the TouchMix reflect how much speaker system headroom is available. Note that the LIMIT LED on the speakers is not a Clip indicator. It will be lit before the mixer's meters indicate any overdrive. This is because the speakers' DSP is preventing dynamic peaks in the program from overdriving the amplifier and speakers.

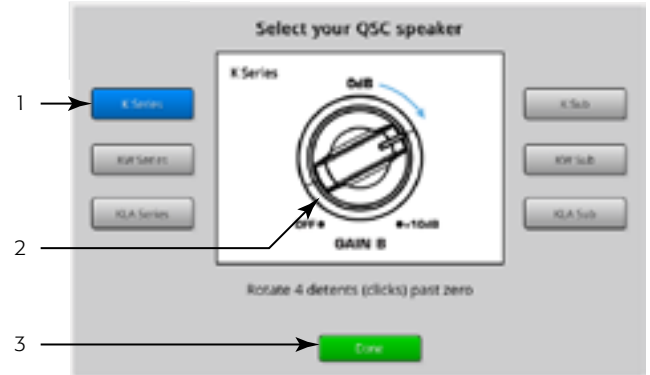

– Figure 37 –

## Other Recommended Speaker Settings

K8, K10, K12	KW121, KW152, K153	KLA12	K-Sub, KW181, KLA181
<b>LF</b> With subwoofer <b>EXT SUB</b> No subwoofer <b>NORM</b>	<b>LF</b> With subwoofer <b>EXT SUB</b> No subwoofer <b>NORM</b>	<b>LF</b> With subwoofer <b>EXT SUB</b> No subwoofer <b>NORM</b>	<b>MODE</b> <b>NORMAL</b>
<b>HF</b> <b>FLAT</b>	<b>HF</b> <b>FLAT</b>	<b>ARRAY SIZE</b> Set to number of KLA12 boxes in the array	<b>POLARITY</b> <b>NORMAL</b>
<b>MIC LINE</b> <b>LINE</b> (channel A only)	<b>MIC</b> <b>0</b>		

## Output Channel – QSC GXD Amplifier Settings

Provides information for properly adjusting QSC GXD Amplifiers when used with the TouchMix.

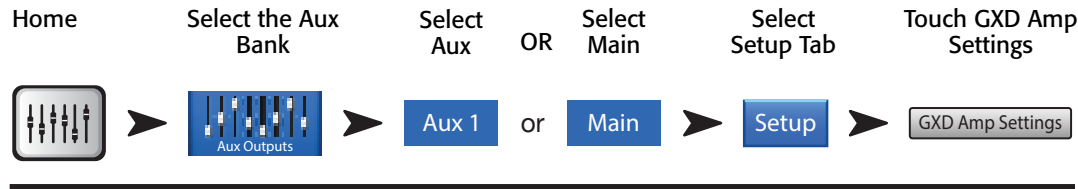

Refer to – Figure 38

On the GXD Amplifier:

- Home** – If the amplifier’s Gain screen is not displayed, press the Home button. If the Gain screen is displayed, skip to the next step.
- Adjust the *Gain A* and *Gain B* knobs for 0.0 dB gain. **Enter** – Moves to the next screen.
- Adjust the *Gain B/DSP Control* knob to select Stereo DSP. **Enter** – Moves to the next screen.
- Adjust the *Gain B/DSP Control* knob to select Sensitivity. **Enter** – Moves to the next screen.
- Adjust the *Gain B/DSP Control* knob to select TouchMix. **Enter** – Confirms selection.
- Home** – Returns to the Home screen.

On the TouchMix:

- Done** – Closes the GXD Amp Settings pop-up.

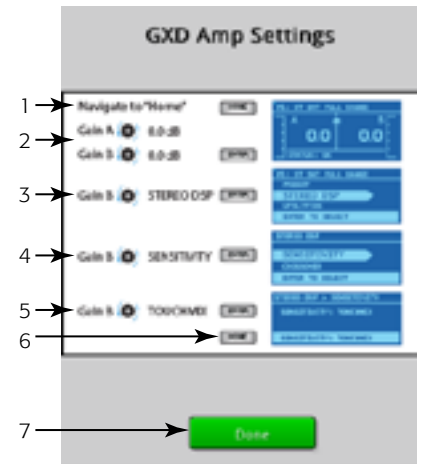

– Figure 38 –

## Aux Overview

Provides an overview of Aux Sends for all Input channels and FX Mixes, along with the Aux Master faders for each Aux mix.

All aux sends, pan controls, and master fader levels may be adjusted by touching to select and using the Master Encoder.



Refer to – Figure 39

- Only **Input** and **FX Master** banks are selectable on the Nav Strip while in the Aux Overview.
- Each **column** (In 1, In 2) represents a channel, and lists the channel’s Aux Sends and pan controls.



**NOTE:** If an input has been given a name, the name will be displayed as the column heading. Touch the Select (name) button to navigate to the input channel’s controls.

- Each **row** represents an **Aux mix**, the name of the mix is displayed in the first column and with the Master fader.
- Pre Fdr/ Post Fdr / Pre Dyn / Pre All** – Indicates the Aux Pick-off point for the selected Aux mix. You can change the setting by going to the Aux Channel Setup tab.
- Aux Master Fader** – Adjusts the overall level of the mix.
- Stereo Aux Master Slider** – A single slider is provided for a stereo pair.
- Pan Control Slider** – Pans the input between the left and right sides of a stereo aux mix.



**NOTE:** If an Aux output is given a user defined name, that name will be displayed above the Aux Master.



– Figure 39 –

# FX Masters

## FX Masters – Effect

FX controls common to all Effects Processors. Refer to the individual FX Processor topics for details.



Refer to – Figure 40

1. **Effect Tab** – Selects the FX Master Effect screen
2. **Aux Send Knobs** (TouchMix-16,, 1–10) (TouchMix-8, 1–4) – Adjust level of processed audio going to the Aux mixes.
3. **Reset Button** – Returns processor and Aux Send controls to their default settings.
4. **Preset Label** – Name of the current preset. Touch to access the library of Presets.
5. **FX Pull-down** – Touch to select a different processor.
6. **Simple Button** – Turns Simple mode on and off. Hides all but the essential controls on the selected FX. The hidden controls are unique to the selected FX device. *The Mono and Stereo Delays do not have a Simple mode.*
7. **Meters** – The Input meter displays the incoming audio level before the FX. The Output meters display the stereo audio level after the FX.
8. **FX Master Fader** – Controls the level of the FX mix to the Main L/R Outputs. Select Pre-fader Listening (PFL) or After-Fader Listening (AFL) on the Mixer Setup screen.



– Figure 40 –

## FX Masters – EQ

Controls and displays the settings for the FX Master channel equalization.



Refer to – Figure 41

1. **EQ Tab** – Selects the FX Master EQ screen.
2. **EQ Graph** – A graphic representation of the EQ settings. The vertical measurement is gain, the horizontal is frequency. In the example, the Low Cut filter and the high Shelf filter are engaged.
3. **Shelf Filter Buttons** – 1 (low), 2 (high) – Engages / disengages the associated shelf filter.
4. **Low Cut Button** – Engages/disengages the low cut filter. This filter cuts frequencies below the frequency set by the Freq control.
5. **Gain Knob** – Adjusts the gain of the associated EQ band over a range of -15 dB to +15 dB.
6. **Frequency Knob** – Sets the frequency at a point 3 dB below 0 for the Low Cut filter and 3 dB above (when gain is negative) or below (when gain is positive) the Gain setting of the associated Shelf Filter.
7. **Reset Button** – Sets all the EQ controls to their factory default position.
8. **EQ In Button** – Engages the equalizer

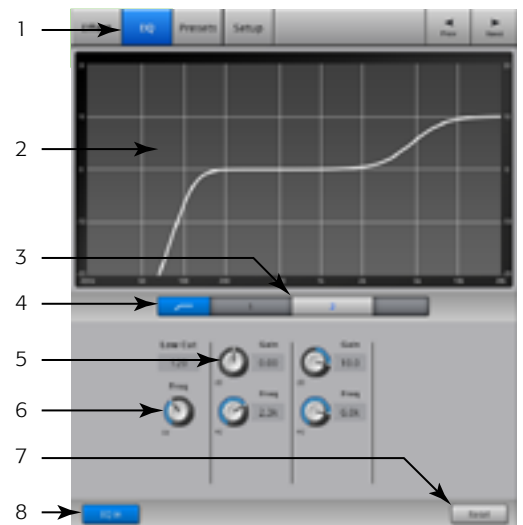

– Figure 41 –

## FX Masters – Preset

Recall presets for the selected FX channel based on the current FX device. All Presets are available for all FX channels.

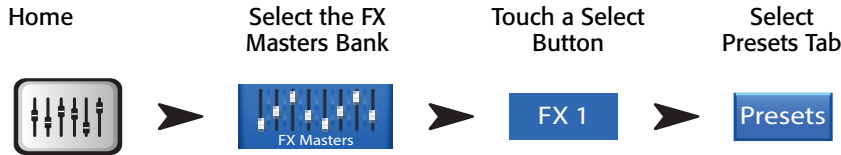

Refer to – Figure 35

1. **Presets Tab** – Selects the Presets screen.
2. **Current Preset Label** – Displays the name of the currently active preset (if any).
3. **Save / Save As Button** – Displays a page with options for naming a scene and selecting internal or USB storage destination.
4. **External (USB) List** – Displays a list of presets that have been saved on an External (USB) drive.
5. **Internal List** – Displays a list of presets that have been stored to Internal mixer memory.
6. **Factory List** – Displays a list of the factory programmed presets available for the currently loaded FX device. Touch a preset name to select.
7. **Delete Button** – Deletes a selected preset from Internal or External user memory.
8. **Copy to USB Button** – Copies the selected preset to an External (USB) Drive.
9. **Copy to Internal Button** – Copies the selected preset to the internal mixer memory.
10. **Recall Preset Button** – Recalls the effects parameters of a preset that has been selected in the Factory, Internal or External (USB) window. Recall does not affect Aux Sends, EQ, Mutes, or Group assignments

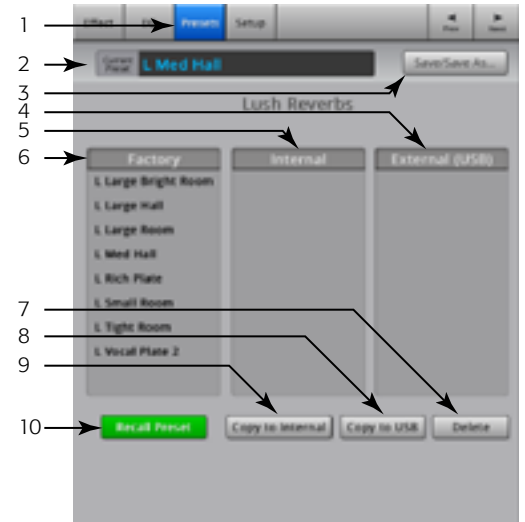

– Figure 42 –

## FX Masters – Setup

Setup allows you to rename the FX Master channel, and assign the channel to Mute and DCA Groups

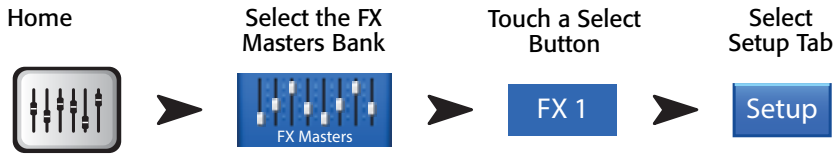

Refer to – Figure 43

1. **Setup Tab** – Selects the Setup screen.
2. **Channel Label** – System name for the FX channel (mix). Does not change.
3. **Name Field** – Touch the Name to display a keyboard that may be used to enter a name for the channel.
4. **Assign To** – Turns the FX channel’s assignment to the Main Left / Right output on and off.
5. **Mute Group Assignment Buttons** – Select the Mute Groups this channel is to be part of. See the Mute Groups topic.
6. **DCA Group Assignment Buttons** – Select the DCA Groups this channel is to be part of. See the DCA Groups topic.

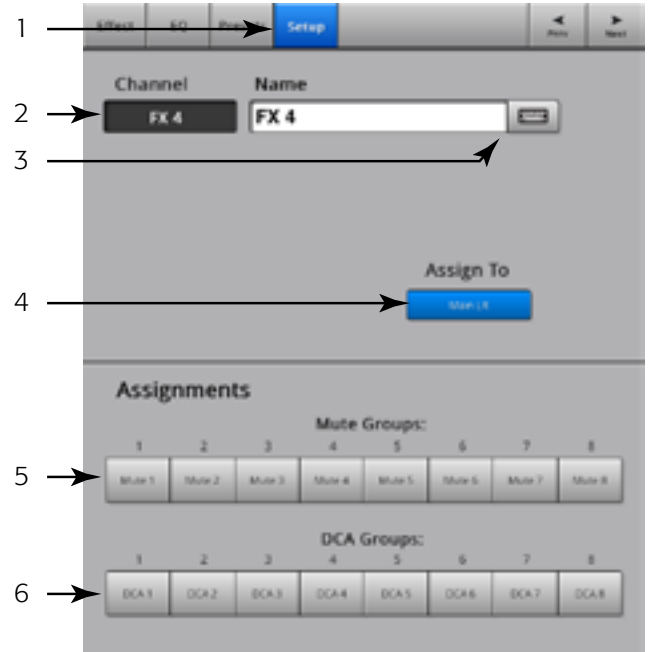

– Figure 43 –

## FX Overview

Provides an overview of the FX Sends for all Input channels, and the FX Master fader for each FX processor. All FX sends and FX master levels may be adjusted by touching the control to select and using the Master Encoder or the Nudge buttons on the iPad.

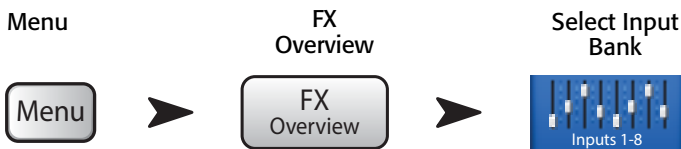

Refer to – Figure 44

1. Only **Input banks** are selectable on the **Nav Strip**.
2. Each **column** (In 1, In 2 ...) represents a **channel**, and lists the channel’s four **FX Sends**.
3. Each **row** represents an **FX mix**, and lists the **FX Sends** for the mix.
4. **FX Master fader** – Adjusts the combined level of all FX Sends for the mix.
5. **FX Processor Icon** – Indicates the currently selected FX device for the FX mix.

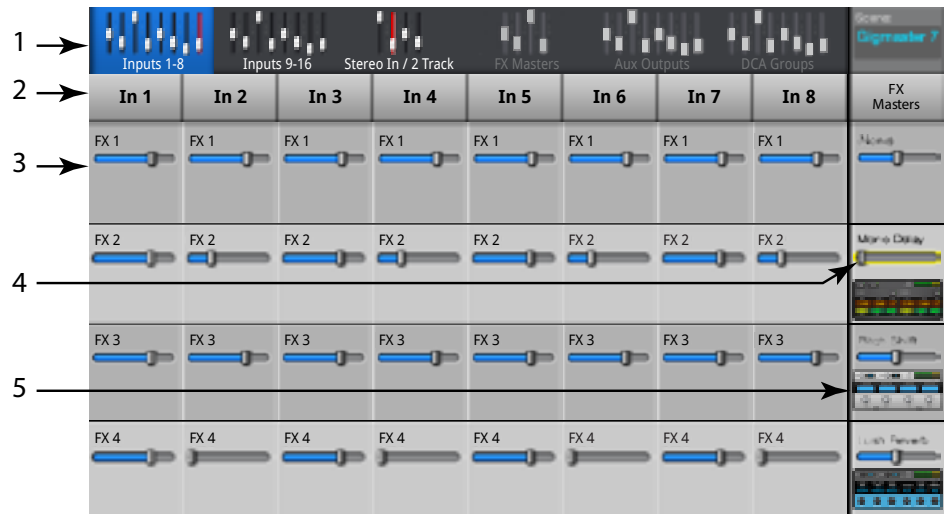

– Figure 44 –



# FX Processors

## FX Processors – Basic Chorus

The Chorus FX Varies the pitch of a signal at a steady rate to “thicken” a sound.

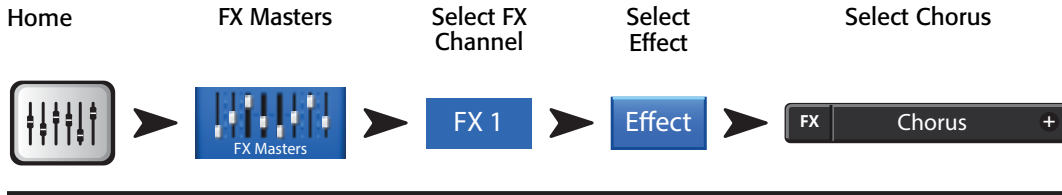

Refer to – Figure 45

1. **LFO Type Switch** – Selects how the pitch will be varied. Sine will vary the pitch smoothly. Saw will cause the pitch to change abruptly and then ramp back.
2. **LFO Rate Knob** – Determines the rate at which the pitch will be varied.
3. **LFO Depth Knob** – Controls the amount of modulation applied to the audio signal.
4. **Lo Cut Knob** – Attenuates, or “cuts” frequencies below this frequency setting. Range is 20 Hz to 2 kHz.
5. **Hi Cut Knob** – Attenuates, or “cuts” frequencies above this frequency setting. Range is 200 Hz to 20 kHz.

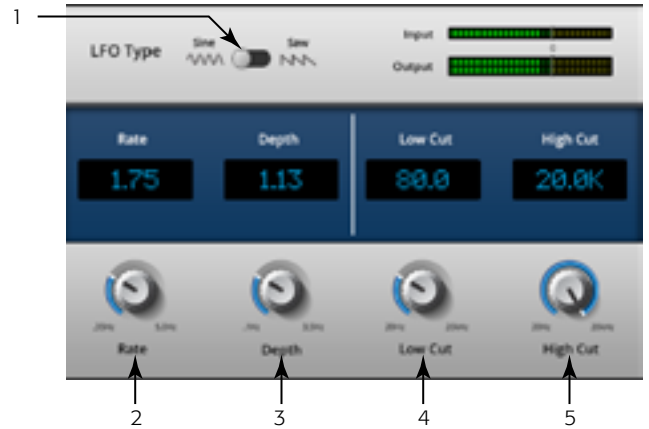

– Figure 45 –

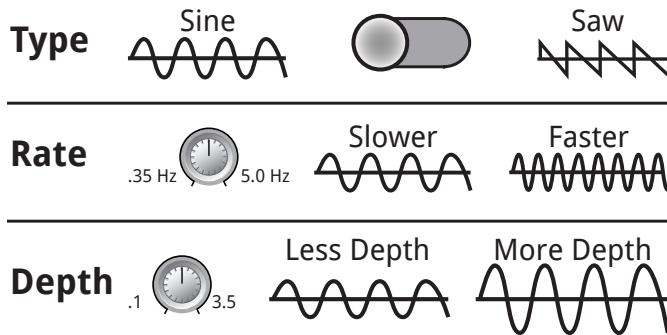

– Figure 46 –

## FX Processors – Dense Reverb

The Dense Reverb (presets with a “D” suffix) is a model of a DSP reverb with more dense reflections that some may find more representative of actual acoustic spaces.

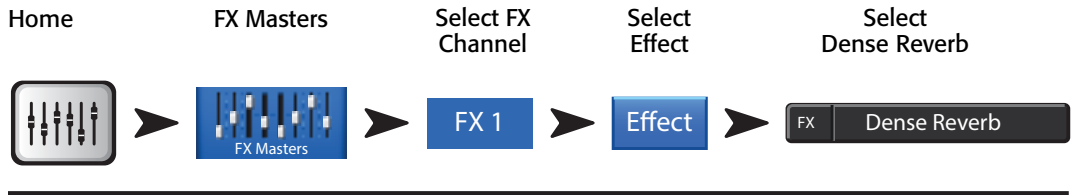

Refer to – Figure 73

1. **Lo Cut Knob** – Attenuates, or “cuts” frequencies below this frequency setting. Range is to 20 Hz to 2 kHz.
2. **Hi Cut Knob** – Attenuates, or “cuts” frequencies above this frequency setting. Range is 200 Hz to 20 kHz.
3. **Reverb Time Knob** – Reverb Time (RT) is the length of time required for the reverberation to drop by 60 dB.
4. **Initial Delay Knob** – Sets the time interval between input signal and first reflection.
5. **High Ratio Knob** – Changes the amount of high frequency reflections.
6. **Diffusion Knob** – Controls the density of groups of Early Reflections. Or Simulates the complexity of surfaces off which the sound reflects.
7. **Reverb Delay Knob** – Changes the delay between reflections.
8. **Early Reflections Knob** – Changes the amplitude of the early reflections.



– Figure 47 –

## FX Processors – Lush Reverb

Lush Reverb (presets with an “L” suffix) is a model of a DSP reverb with a more “lush” character.

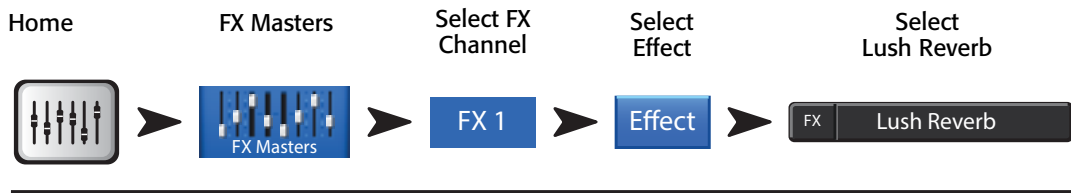

Refer to – Figure 48

1. **Lo Cut Knob** – Attenuates, or “cuts” frequencies below this frequency setting. Range is 20 Hz to 2 kHz.
2. **Hi Cut Knob** – Attenuates, or “cuts” frequencies above this frequency setting. Range is 200 Hz to 20 kHz.
3. **Size Knob** – The longest dimension of the simulated acoustic space in meters.
4. **Pre Delay Knob** – Sets the time interval between input signal and first reflection
5. **Low Reverb Knob** – Adjusts the reverb decay time for frequencies below the crossover frequency.
6. **Crossover Knob** – Sets the crossover point for the Low Reverb Time and the High Reverb Time.
7. **High Reverb Knob** – Adjusts the reverb decay time for frequencies above the crossover frequency.
8. **Diffusion Knob** – Adjusts the early reflections to simulate a more complex or less complex reflective acoustic surface.



– Figure 48 –

## FX Processors – Mono and Stereo Delay

These effects delay the audio signal to create echo and similar effects. Controls for the stereo delay may be linked or operated independently.

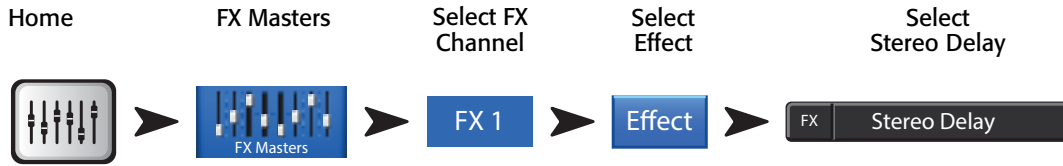

Refer to – Figure 50



**NOTE:** The screenshot at the right is from an iPad, the Tap Tempo buttons are shown for illustration only. The Tap Tempo buttons are not available on remote devices.

- Lo Cut Knob** – Attenuates, or “cuts” frequencies below this frequency setting. Range is 20 Hz to 2 kHz.
- Hi Cut Knob** – Attenuates, or “cuts” frequencies above this frequency setting. Range is 200 Hz to 20 kHz.
- Delay Knob** – Sets the time between the dry audio and the delayed audio.
- Tap Tempo Knob** – Sets the tempo of the regenerations by tapping. Touch the Tap Tempo button, then tap the Master Control knob at a steady rate.
- Regeneration Knob** – Adjusts the amount of delayed signal that is sent back to the input. At 0% only the first echo will be heard. At 99% the echo will repeat indefinitely at the same level.
- Channel Linking Knob** (*Stereo Delay only*) – Links all controls of both channels. Channel two is set to the same level as Channel one.



– Figure 49 –

## FX Processors – Pitch Shift

The Pitch Shift raises or lowers the pitch of an audio signal by a fixed interval. In addition, the signal can be delayed from the original. The two output channels can be adjusted independently.

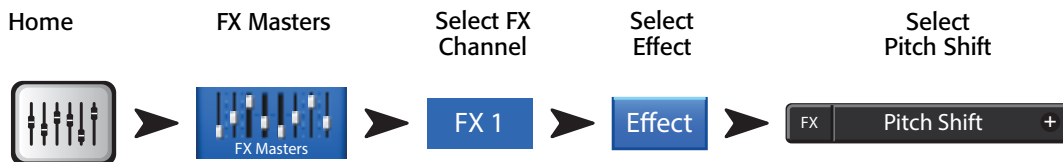

Refer to – Figure 50

- Lo Cut Knob** – Attenuates, or “cuts” frequencies below this frequency setting. Range is 20 Hz to 2 kHz.
- Hi Cut Knob** – Attenuates, or “cuts” frequencies above this frequency setting. Range is 200 Hz to 20 kHz.
- Left and Right Shift Knobs** – Sets the amount of shift, down (-) or up (+) for the two output channels.
  - 100ç = 1 half step,
  - 200 ç = 1 whole step,
  - 1200ç = 1 octave

Rotating the Master Encoder will change the amount of pitch shift in half-step intervals. For finer adjustments, hold the Encoder down while adjusting.

- Left and Right Delay Knobs** – Adds up to 100 milliseconds of delay to the Pitch Shift output.



– Figure 50 –

# Menu

The Menu provides links to some of the mixer's functionality and global settings. In addition the Menu provides quick access to Clear Clip, Mute, Cue, and global Screen mode.

Press Menu

Menu

Touch a button to access the functionality.

Titles 1 through 12 have individual help topics.

1. **DCA Groups** – Refer to [DCA Groups on page 55](#).
2. **Security** – Refer to [Security on page 54](#).
3. **Scenes** – Refer to [Scenes on page 53](#).
4. **FX Overview** – Refer to [FX Overview on page 48](#).
5. **Remote Control Settings** – Refer to [Remote Control Settings on page 56](#).
6. **Aux Overview** – Refer to [Aux Overview on page 45](#).
7. **Language** – Select 中文, Deutsch, English, Français, Русский Español. The languages changes for the Info screens and the Demo screens.
8. **MIDI Setup** – Refer to [MIDI Setup on page 57](#).
9. **User Buttons** – Refer to [User Buttons on page 58](#).
10. **Mic Phantom** – Refer to [Phantom Power on page 60](#).
11. **Talkback** – Refer to [Talkback / Noise on page 60](#).
12. **Mixer Setup** – Refer to [Mixer Setup on page 59](#).
13. **Clear Clip** – Resets clip indications on the Nav Strip. The clip indications are cleared only on the device on which the clear Clip button was pressed. By default, User Button 2 also performs this function.
14. **Clear Mute** – Unmutes all Mutes except Mute Groups, and DCA Mutes.
15. **Clear Cue** – Clears the Cue. By default, User Button 3 also performs this function.
16. **Advanced** – displays and allows access to all controls on all screens having Advanced and Simple mode. You can change individual screens to the Simple mode as you wish.
17. **Simple** – displays a reduced set of controls on all screens having Advanced and Simple mode. You can change individual screens to the Advanced mode as you wish.

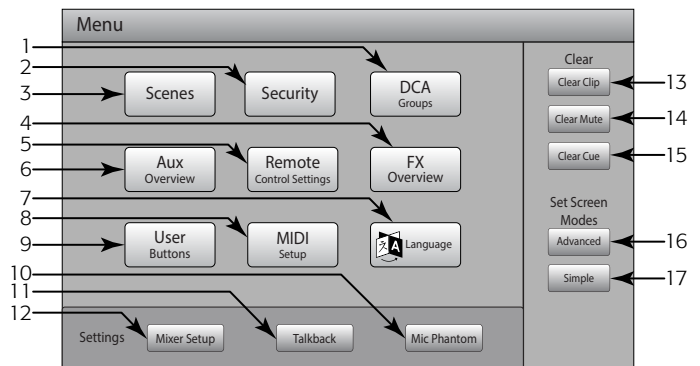

– Figure 51 –



**NOTE:** Switching from Advanced to Simple will not change any control value settings.

## Scenes

Scenes provide the ability to store and recall all mix parameters.

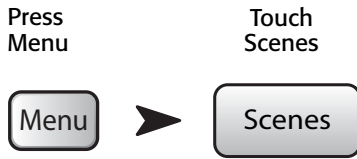

Refer to – Figure 52

1. **Current Scene Label** – Displays the name of the most recently recalled scene.
2. **Save / Save As Button** – Displays a page with options for naming a scene and selecting internal or USB storage.
3. **External (USB) List (User)** – Saves scene data to the a USB storage device.
4. **Internal Scenes List (User)** – Saves scene data to the mixer’s internal storage.
5. **Factory Scenes List** – A library of preset scenes representing mixer settings for a variety of bands, productions and styles. Factory memory is read-only.
6. **Delete Button** – Deletes the selected Internal or External Scene.



**NOTE:** To copy a Factory scene, first recall the Factory scene, then use the Save/Save-as feature to save it to the desired location.

7. **Copy to USB Button** – Allows scenes to be moved/copied between USB memory and internal memory. Factory memory is read-only.
8. **Copy to Internal Button** – Allows scenes to be moved/copied between USB memory and internal memory.
9. **Recall Preset Button** – Recalls the selected Scene. Does not change Wi-Fi network settings.
10. **Include / Omit Levels Switch** – When engaged (omit), all Faders, FX Sends, and Aux Sends are not recalled.



**NOTE:** The mixer saves the state of all controls every 30 seconds. If you are making a lot of changes, the mixer can wait up to one minute to save. When power is removed from the mixer, then restored, the mixer returns to the state of the last auto save.



**NOTE:** It is possible to recall a TouchMix-16, scene on a TouchMix-8, and recall a TouchMix-8 scene on a TouchMix-16,. The TouchMix-8 will simply ignore those input channels and mix buses it doesn’t have. The TouchMix-16, changes all the settings the TouchMix-8 scene has. Factory Stereo channel settings update the Factory Stereo channels on the mixer. Channels 9/10 and 11/12 on the TouchMix-8 change Channels 17/18 and 19/20 on the TouchMix-16, and vice versa.

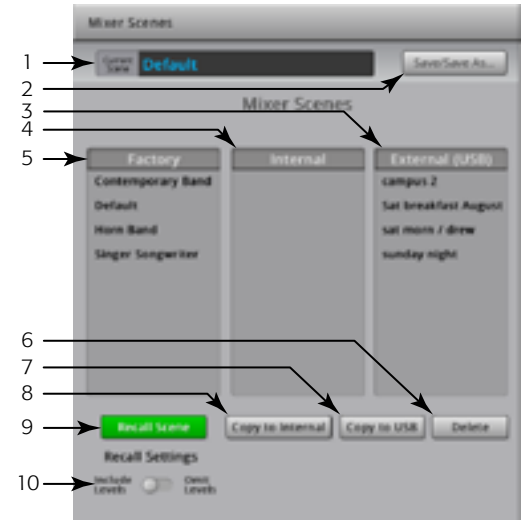

– Figure 52 –

# Security

Provides four levels of password-enabled security to TouchMix functionality.



Refer to – Figure 53

## 1. Passwords



**IMPORTANT:** Setting the password for Administrator enables the Security feature. Leave this field empty to operate the mixer without security restrictions.

- **Administrator** – Users logging in with this password may access all mixer functions including Security Setup.
  - **All Access** – Allows access to all mixer functions except Security Setup.
  - **Simple Mode Only** – Allows access to all simple-mode mixer functions for screens having a Simple / Advance choice, and all other functions except Security Setup.
  - **Levels Only** – Access to level controls only.
2. **Overwrite Scenes & Presets** – Enables or disables ability to overwrite Scenes and Presets on the mixer, or external hard drive. The switch is available for all security levels except Administrator.
  3. **Recall Scenes** – Enables or disables ability to recall Scenes on the mixer, or external hard drive. The switch is available for all security levels except Administrator.
  4. **Recall Presets** – Enables or disables the ability to recall Presets on the mixer, or external hard drive. The switch is available for all security levels except Administrator and Levels Only.
  5. **Hours and Minutes** – Sets the amount of time it takes for the Auto Lock to be activated. Once the mixer is locked, login is required for levels assigned a password.

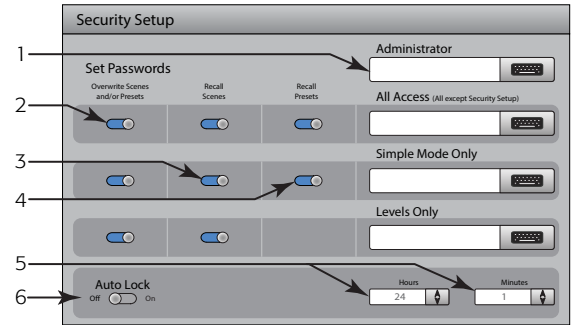

– Figure 53 –

## DCA Groups

DCA Groups allow you to mute and control the signal level of channels assigned to it. The DCA does not move the faders or change the mute state of channels assigned to it.



Refer to – Figure 54



**NOTE:** You can also access the DCA Groups screen by touching Menu > DCA Groups, or assign a DCA Group from the channel Setup screens.

### About DCA Groups

- When a channel is in one or more DCA Groups, the output of that channel is equal to the sum of the DCA fader settings and channel fader settings.
- When a channel is in one or more DCA Groups, the channel and all the DCA Groups must be unmuted for audio to pass. The same rule applies when a channel is in a DCA, and Mute Group – all must be unmuted for audio to pass.

1. **DCA Select Button** – Selects the associated DCA group to add or remove channels.
2. **DCA System Name Label** – This name does not change.
3. **User-defined Name Field** – Touch the name field to display a keyboard that may be used to enter a name for the DCA Group.
4. **Clear Button** – Clears all assignments from the selected DCA Group.
5. **Assignment Buttons** – Touch one of the channel Assignment buttons to add the channel to the selected DCA Group. You can assign all channel types except DCAs.

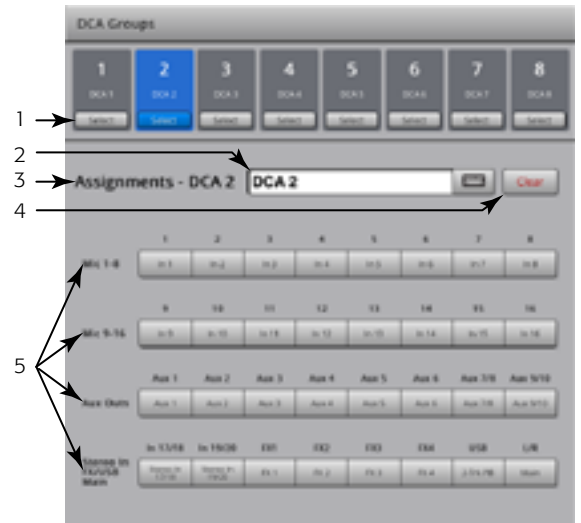

– Figure 54 –

### Aux Overview

For details refer to [Aux Overview on page 45](#)

Provides an overview of Aux Sends for all Input channels and FX Mixes, along with the Aux Master faders for each Aux mix.

All aux sends, pan controls, and master fader levels may be adjusted by touching to select and using the Master Encoder.



## Remote Control Settings

Controls the availability of mixer functionality to logged-in devices on a device by device basis. When a new device connects to the mixer's network and the TouchMix Control App is launched, the mixer displays a message indicating that a new device is connected.

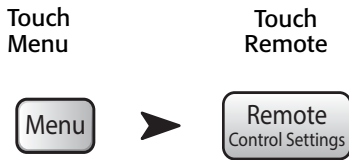

Refer to – Figure 55 (Section A is for Personal Monitor Mix, section B is for Full Access.)

1. **Devices:** Lists the remote devices that are, or have been connected to the TouchMix. Blue highlight indicates selection.
2. **Access Control:** Personal Monitor Mix enables you to select the functionality you want to allow for the selected device. Full Access gives the remote device full access and allows for a password-secured login.



**NOTE:** When a remote device is set to **Personal Monitor Mix**, the **Cue** and **Mute** buttons are not available on the Aux-Mix-on-Faders.

3. **Functionality selection** – Blue indicates function is allowed, gray indicates function is not allowed.
  - a. **Main Mix** – Access and control of the main mix controls.
  - b. **Record** – Access and control of the recording functionality.
  - c. **User Buttons** – Access to change the functions assigned to the User Buttons.
  - d. **Auxiliary Channels** – Access to individual aux channel mixes. Great for the on-stage performers.

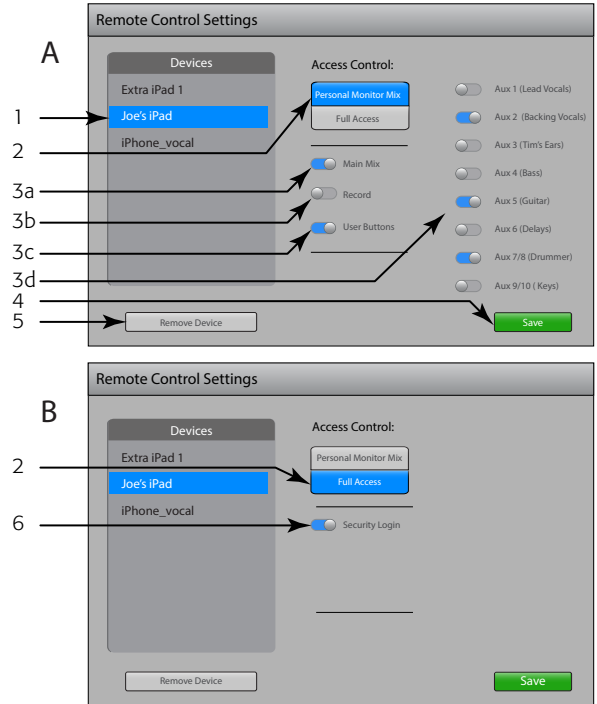

– Figure 55 –

4. **Save** – Saves the settings for the selected device. A message indicating what functions are available is sent to the device.
5. **Remove Device** – Removes the selected device from the list.
6. **Security Login:** – Determines if the user of the selected device must login or not. Must have the mixer Security functionality enabled. See Security.

## FX Overview

For details refer to [FX Overview on page 48](#).

Provides an overview of the FX Sends for all Input channels, and the FX Master fader for each FX processor. All FX sends and FX master levels may be adjusted by touching the control to select and using the Master Encoder or the Nudge buttons on the iPad.

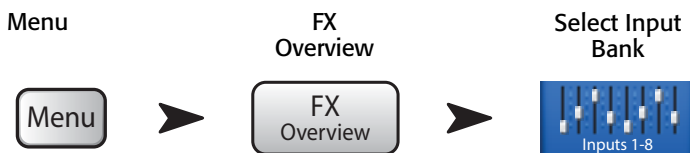



## MIDI Setup

The MIDI (Musical Instrument Digital Interface) Setup provides the means to use a USB MIDI foot switch to control many functions of the TouchMix mixer.



Refer to – Figure 56

1. Touch to select the MIDI channel. The current MIDI assignments are displayed on buttons 1 – 8. Blue indicates the MIDI channel is selected and can be assigned/unassigned or renamed.
2. Name of the MIDI function. Click to rename. When you change the MIDI assignment for the MIDI button, the name changes to the default name of your selection.
3. Select an item from each of the lists in the order shown – Action, Selection, Detail.
4. Blue indicates the current selection for the list.
5. MIDI Assignment – The name of the assignment made internally to the USB MIDI foot switch button.
6. Learn MIDI –
  - i. Touch this button to teach the TouchMix what MIDI command should trigger the selected action. A message displays saying, “Waiting for incoming MIDI message...”
  - ii. Press a button on the USB MIDI foot switch.
  - iii. When the learned MIDI command is given, the TouchMix responds by executing the assigned function.
7. Unassign – Touch this button to remove the assignment to the selected MIDI button.
8. Assign – Touch this button to complete the assignment.

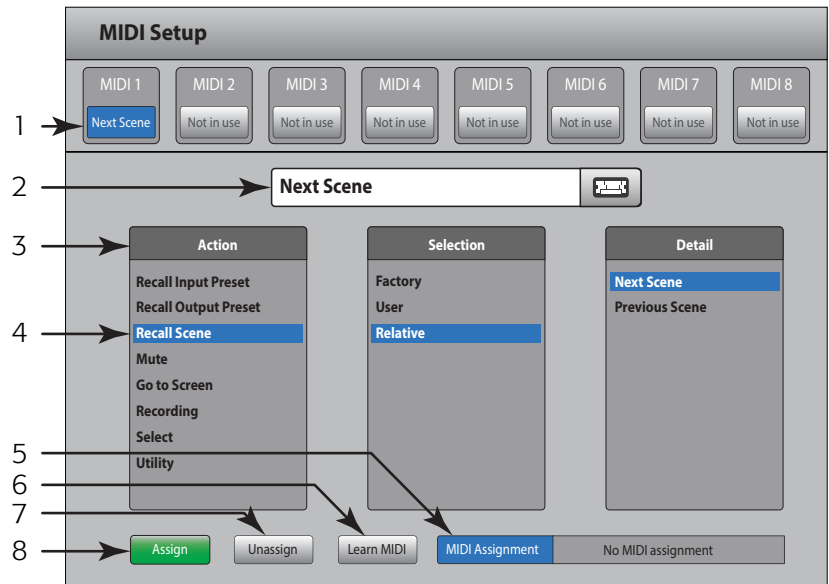

– Figure 56 –



**NOTE: PITCH CORRECT** – This function disables or enables the Pitch Correct feature, it does not affect the assignment of the feature to a channel.

## User Buttons

Provides a means to assign the four User Buttons to various functions giving one-touch access to the assigned function.



Refer to – Figure 55

By default the User buttons are assigned to:

- **Navigate Left** (U1)
- **Clear Clip** (U2)
- **Clear Cue** (U3)
- **Navigate Right** (U4).

1. Current User Button functions 1 – 4.
2. Blue indicates the User Button is selected and can be changed or renamed. The current function is displayed in the Action, Selection, and Detail list boxes.
3. Name of the User Button. Click to rename. When you change the function assigned to the button, the name changes to the default for what you selected.
4. Select an item from each of the lists in the order shown – Action, Selection, Detail.
5. Blue indicates the current selection for the list.
6. Reset – Resets the selected User Button to its default setting.
7. Assign – press this button to complete the assignment.

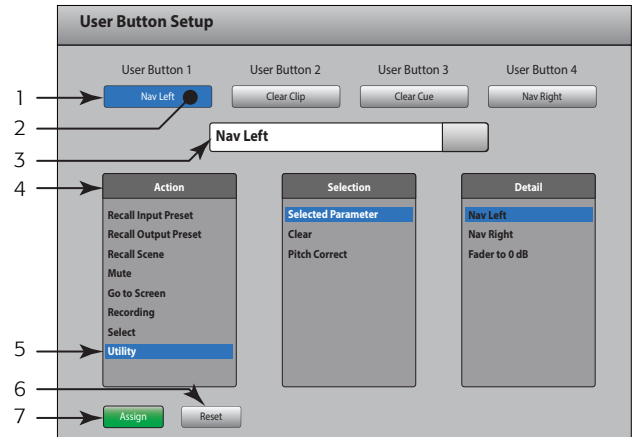

– Figure 57 –



**NOTE: PITCH CORRECT:** This function disables or enables the Pitch Correct feature, it does not affect the assignment of the feature to a channel. The only way you can tell if this feature is enabled or disabled at the User Button level is to see if you can hear a difference when Pitch Correct is assigned to a channel. If you select Utility > Pitch Correct >, you need two user buttons, one to enable the feature, the other to disable it. Refer to [Input Channel – Pitch Correct on page 35](#) for information about assigning or enabling Pitch Correct for a channel.

**Alternate Method** of setting a User button to navigate to a specific screen. Does not apply to remote devices.

1. Navigate to the desired page.
2. Press and hold a user button for 2 - 3 seconds.
3. Upon release, a message appears. Touch "Yes" to accept the change or "Cancel" to reject it.
4. You can give the user button a friendly name from the User Button Setup screen.

To return the user button to the factory default, press it one time to access the assigned page. Then push and hold the user button for 2-3 seconds.

## Mixer Setup

Control various global and utility functions.

Press  
Menu

Touch  
Mixer Setup



– Figure 58 refers to the TouchMix, – Figure 59 refers to the iPad App.

1. **Display Brightness Knob**<sup>1</sup> – Controls the brightness of the LCD screen and the illuminated buttons on the TouchMix.
2. **Cue Mode Switch** – Changes the Cue pick-off point to pre-fader listen (PFL), or after-fader listen (AFL).
3. **Sample Rate Switch** – Selects the sample frequency (bit rate) for the mixer. Most relevant for recording. Typically, 44100 is used for audio CD, and 48000 for audio with video.
4. **Dynamics Processing Switch**<sup>1</sup> (Global) – Determines whether all input channel gates and compressors are controlled by a pre or post EQ signal.
5. **Demo Mode Switch**<sup>1</sup> – Demo mode provides a slide show that highlights some of the TouchMix features.
6. **Clear Storage Button** – Deletes all user-defined presets and scenes from the mixer. Does not delete presets or scenes stored on a USB device.
7. **Software Version Label** – Displays the version number of the currently installed firmware. If you are using a remote device, you must be connected to the TouchMix to see the TouchMix software version. The App version is shown in the remote device's settings.
8. **Upgrade Button**<sup>1</sup> – When QSC makes an update to the TouchMix firmware, you can download it from the QSC website and onto a USB device. After inserting the USB device into the TouchMix, touch the Upgrade button to start the process. Follow the instructions on screen.
9. **End User License Agreement** – Please read this agreement before using your TouchMix.
10. **Save System Log to USB Button**<sup>1</sup> – The TouchMix saves various events that take place when the TouchMix is on. This log can be saved to a USB device then sent to QSC Technical Support for use in troubleshooting TouchMix system errors. This file requires special software to read it.
11. **Network Setup Button**<sup>1</sup> – Takes you to the [Network Setup](#) screen.
12. **Reset Mixer Button** – Resets all mixer controls to the factory default. This does not erase any user presets on the mixer or on a USB drive.
13. **Select Mixer... Button** – This function applies to remote devices only. Touch this control to select a mixer when more than one TouchMix mixer is connected to the network.

<sup>1</sup> Not available on remote devices.

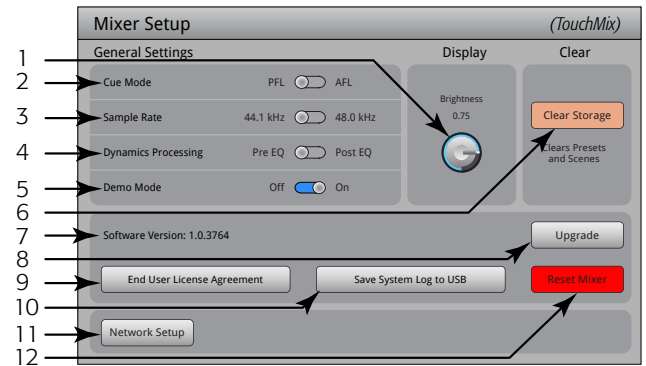

– Figure 58 –

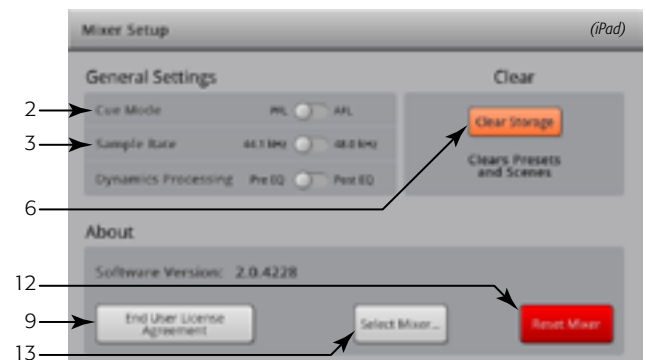

– Figure 59 –

## Talkback / Noise

This screen controls the routing and level of Talkback and Noise.



**NOTE:** Talkback is available only on the TouchMix-16, Noise is available on both models.



Refer to – Figure 60 (TouchMix-8 does not have the Talkback feature.)

- Assignments** – These buttons select the destination for the noise or talkback signals. Note that it is possible to route talkback to the four FX devices. This is very useful when auditioning and selecting effects.
- Talk Level** – Adjusts the level of the talkback signal to the assigned outputs. -Inf (Infinity) is off.
- Talkback Enable** – Touch to enable Talkback, touch again to disable Talkback. Unlike the mixer’s hold-to-talk Talk button, this button is latching. When enabled, the hold-to-talk button is illuminated. On the iPad, both Talk and Enable are latching.
- Noise Level** – Adjusts the level of the noise signal to the assigned outputs. -Inf (Infinity) is off.
- Noise Enable** – Touch to enable Noise, touch again to disable Noise.

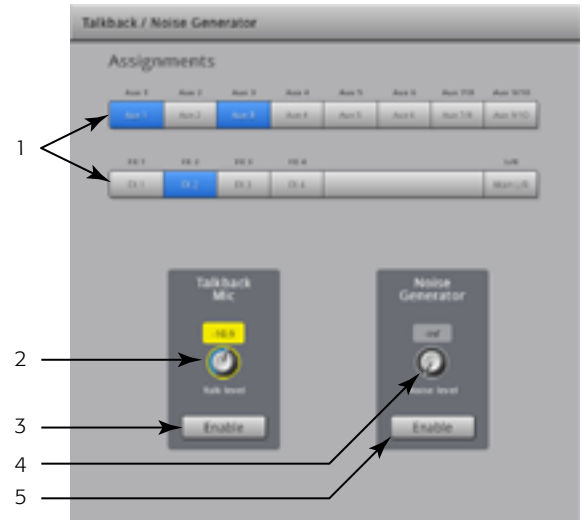

– Figure 60 –

## Phantom Power

Supplies +48 VDC to XLR Inputs only when using an XLR connector. Phantom power is not available on any 1/4" TRS connectors.



Refer to – Figure 61

- Input Selection On** – Touch the Input channel name button, or the corresponding XLR icon to turn +48V on or off. Red indicates on.
  - Input Selection Off** – Touch the Input channel name button, or the corresponding XLR icon to turn +48V off. Gray indicates off.
- In addition, Phantom power may be switched on and off from the Setup screen of each input channel.

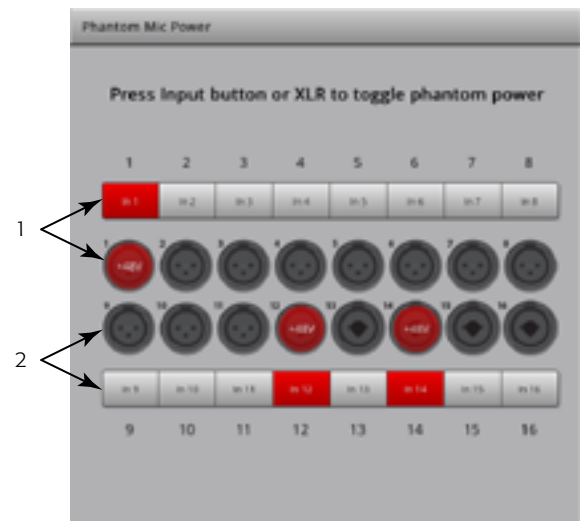

– Figure 61 –

## Network Setup

Network setup is done on the TouchMix only.

### Wireless Network Setup

Manages the mixer's Wireless Network. Connect iPhones and iPads running Apple iOS6 or later.

Make sure the supplied Wireless USB Adapter is installed in one of the mixer's USB ports. Use only the adapter supplied with the mixer.



**IMPORTANT:** Do not remove or install the Wireless USB Adapter while recording or playing back audio.



Refer to – Figure 62 (Section A is for creating your own network, section B is for connecting to an existing network.)

- Mixer Name: (Network SSID)** – The Name of the mixer's network (A) or the network SSID of an existing network (B). Touch the name to display a keyboard and enter a network name.
- Edit Settings for:** – Provides a choice to set up a wireless or wired network for the mixer.
- Network Mode:** – When setting up a wireless network, you can create a network on the mixer (A), or connect to an existing network (B).
- Set Network Password:** – Displays the password for the network to which your device will connect. Touch the Name to display a keyboard that you can use to enter a Password for the network. When creating your own network (A), the password must be numeric; 0-9 only, and must be 10 characters. An existing network (B) may have restrictions as well.
- Scan...** – When connecting to an existing network (B), touch the Scan... button to display a list of networks from which you can select. Touch the network you want, then touch Select. The Network SSID is automatically populated.
- Signal Strength:** – Shows the signal strength of the existing network (B) you have selected.
- Security:** – When connecting to an existing network (B), select the security protocol used by the existing network.
- Apply** – After making the selections for a network, touch the Apply button to configure the network. A message displays indicating that the network is being configured.

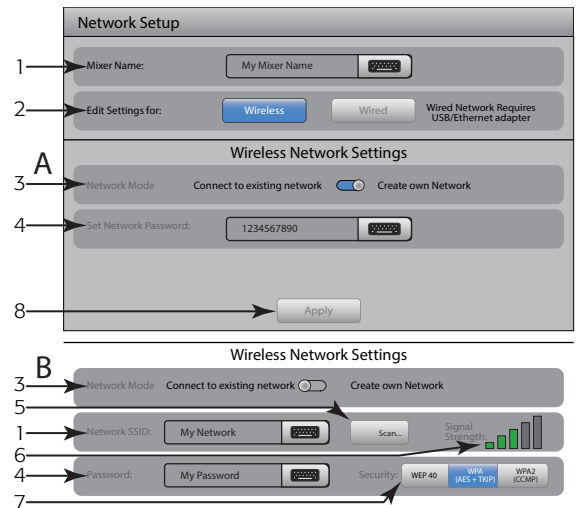

– Figure 62 –

## Wired Network Setup

Manage the mixer's Wired Network. Connect iPhones and iPads running Apple iOS6 or later.

Install a USB/Ethernet Adapter into one of the mixer's USB ports. Any adapter based on the ASIX AX88772 chipset should work. Adapters based on other chipsets including newer versions of USB 3.0/Ethernet adapters from ASIX do not work.



**IMPORTANT:** Do not remove or install the USB/Ethernet Adapter while recording or playing back audio.

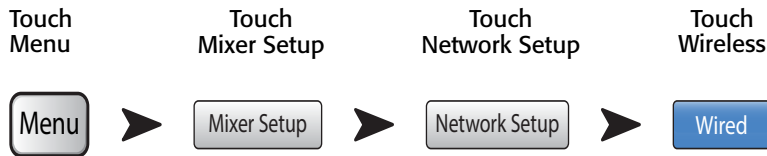

Refer to – Figure 63 (Section A is for static network, section B is for automatically connecting to a network.)

1. **Mixer Name: (Network SSID)** – The name of the mixer's network or the name of an existing network. Touch the name to display a keyboard and enter a network name.
2. **Edit Settings for:** – Provides a choice to set up a wired or wireless network for the mixer.
3. **IP Address Assignment:** – When setting up a wired network, you can use a static IP Address that you type in, or use an automatically set IP Address.
4. **Network Status** – Red indicates a problem like “Adapter not Present”, green indicates the TouchMix is connected to the network.
5. **Network IP Address, Network Mask, and Network Gateway** – These are the required identifiers for the network to which you want to connect.
6. **Apply** – After making the selections for a network, touch the Apply button to configure the network. A message displays indicating that the network is being configured.

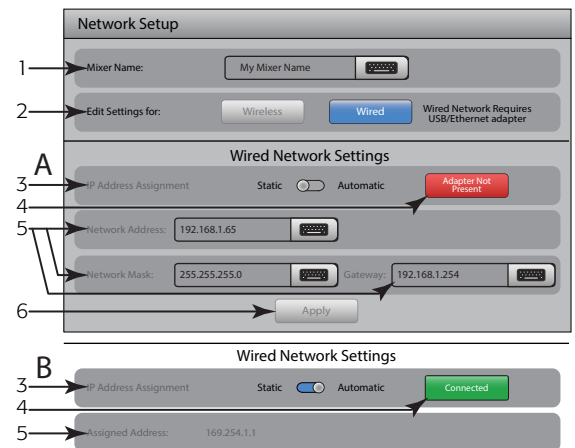

– Figure 63 –

## Network Troubleshooting

If you are having trouble connecting your iOS device to your TouchMix here are a few tips.

1. Check the software version on the mixer (**Menu > Mixer Setup > Software Version**) and your iOS device (**Settings > TouchMix > Version**).
  - If the TouchMix software version is 2.0.xxx, the iOS TouchMix App must be 2.0.xxxx.
  - If the TouchMix software version is 1.xx.xxxx, the iOS TouchMix App must be 1.xx.xxxx.
  - If you are in doubt, download the latest TouchMix software from QSC.com, and the latest TouchMix App from the App Store.
2. Are other iOS devices able to see and log on to the TouchMix?
  - If not, the problem may be with the TouchMix Network Setup.
  - Do the TouchMix Network Setup settings correspond to the Wi-Fi hardware you've connected to the mixer? Version 2.0 and later firmware offers more Wi-Fi options than just a point-to-point connection between mixer and iOS device. Make sure that, for example, the “Wired” option hasn't been selected when no USB-to-Ethernet adapter is present. See the instructions on [Network Setup on page 61](#).
3. If other iOS devices are able to connect to the mixer...
  - Verify the TouchMix network password and re-type it into the Wi-Fi settings of you device.
  - Restart your iOS device by pressing and holding the Sleep/Wake button. The “Slide to power off” slider will appear. Drag it to power down and wait for your device to complete the cycle. Press and hold the Sleep/Wake button until the Apple logo appears.
  - Force close and restart the TouchMix App. Press the iOS device Home button twice in rapid succession. Swipe left until you see the TouchMix App. Swipe up on the TouchMix App and then restart normally.
  - Visit the Apple support site at <http://www.apple.com/support/> and search for ‘iOS wi-fi troubleshooting’.

# Mute Groups

Mute Groups allow you to mute a group of assigned channels, at the same time, by pressing the Mute Group mute button.

Press Mute Groups



## About Mute Groups

When a channel is in one or more Mute Groups, all Mute Groups containing the same channel and the Channel Mute itself, must be unmuted for audio to pass.

## Mute Groups Mute Screen

Refer to – Figure 64

1. **Edit Button** – Touch the Edit button to add or remove channels from Mute Groups.
2. **Mute Group Buttons** – From the Mute Groups screen you can mute or unmute any of the eight Mute Groups.

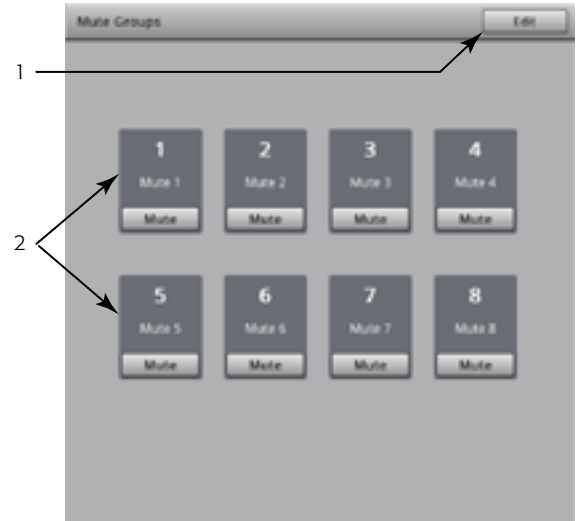

– Figure 64 –

## Mute Group Edit Screen

Refer to – Figure 65

1. **Close Edit Button** – Returns to the Mute Group Mute screen.
  2. **Mute Group Select Buttons** – Selects the Mute Group for editing.
  3. **Mute Buttons** – Mutes / unmutes the channels assigned to the Mute Group.
- NOTE:** Channel Mute (on Home screen) – When a channel is muted by a Mute Group only, the channel Mute button is a lighter shade of red. (not gray)
4. **User-Defined Name** – Touch the name to display a keyboard that may be used to enter a name for the Mute Group.
  5. **Mute Group System Label** – This name does not change.
  6. **Clear Button** – Clears all assignments from the selected Mute Group.
  7. **Assignment Buttons** – Touch one of the channel Assignment buttons to add the channel to the selected Mute Group. You can assign all channel types except DCAs.

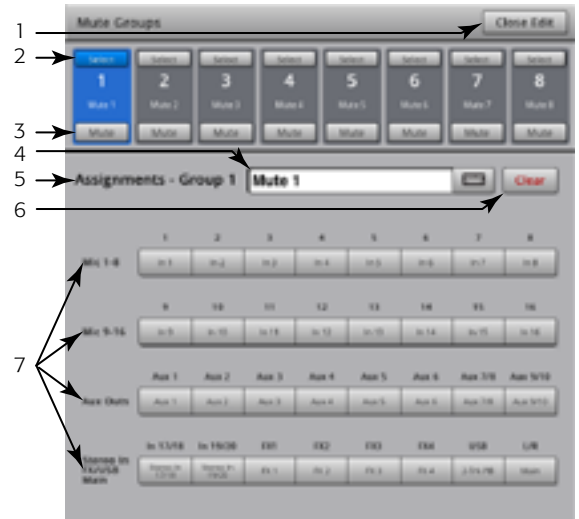

– Figure 65 –

# Phones and Monitor

Controls the output level for the Phones Cue and Monitor Cue

Press  
Phones

OR

Press  
Monitor



Refer to – Figure 66



**NOTE:** The Monitor Level control is available only on the TouchMix-16.

**Phones (1) and Monitor (2) Level** – Controls the level of the Cue signal on the Phones and Monitor outputs.



**NOTE:** By default, no audio signal is sent to the Phones / Monitor Outputs. To send audio channel signals (including Main LR) to the Phones / Monitor Outputs. Enable the Cue button for the channels you want to listen to.

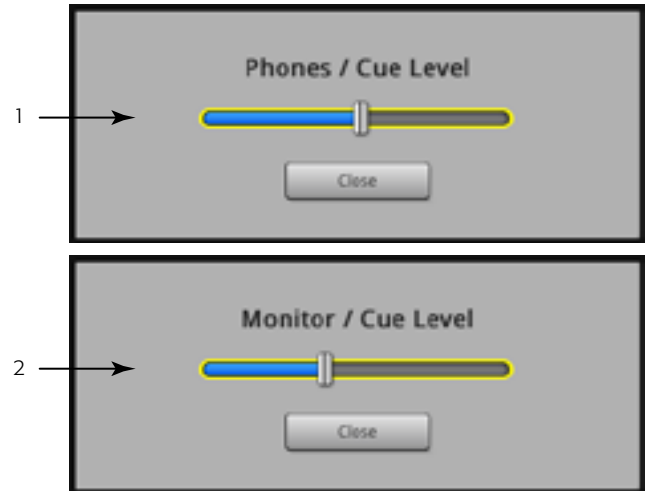

– Figure 66 –



# Record / Playback

## Main Screen

Provides the controls to record and playback multiple channels.



**IMPORTANT:** All USB memory devices must be formatted as FAT32 to work with TouchMix. Drive performance is critical for recording. For more information and to see a list of qualified drives, visit [qsc.com](http://qsc.com). At this time, the TouchMix does not support importing or re-importing digital audio files that have been created or edited on another device.

Press  
Record / Play



Refer to – Figure 67



**NOTE:** All the standard channel controls act as they do regardless of record / playback status. For example, if you Mute the channel that is recording, the output gets muted, but recording of the input continues.

1. **Bank Selectors** – You must have an Input Channel bank selected to setup recording or playback.
2. **Track Indicator** – Indicates that a recorded track is the audio source for the channel. Displays here and on the Home screen.
3. **Armed Indicator** – Indicates that the channel is armed for recording. Displays here and on the Home screen.
4. **Track Source Switch** – Selects analog input (left) or track (right) for the audio source of the channel.
5. **Arm Button** – Engage to select a channel to be recorded.
6. **New/Recall Session Button/Label** – Navigates to the Recording Setup screen where sessions and recording utility functions may be managed. In addition, the name of the currently active Session is displayed.
7. **Transport Control Buttons** – Standard controls. To record and playback at the same time, arm the inputs you want to record, select Track for the tracks you want to playback, then touch the Play button.
8. **Time Code Display** – Displays position of the Play pointer in HH:MM:SS. Maximum record time is determined by the capacity of the attached hard-disc drive.

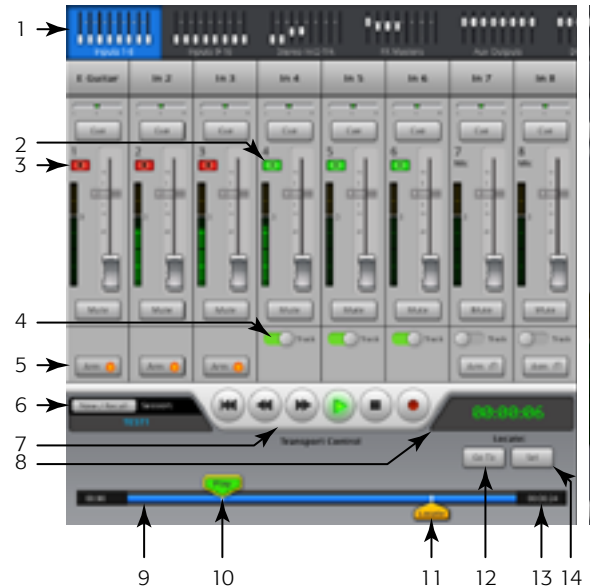

– Figure 67 –

9. **Time Line** – Represents the session time line.
10. **Play Pointer** – Indicates current record/playback position.
11. **Locate Pointer** – The Locate pointer holds a set place on the Time Line to which the Play pointer can be relocated.
  - a. Position the **Play** pointer.
  - b. Touch the **Set** button.
  - c. Touch **Go To** to return to that spot.
12. **Go To Button** – Repositions the Play pointer to the position of the Locate pointer.
13. **Total Record Time Counter** – The total length of the recording in HH:MM:SS. If recording is in progress, this number grows until the recording is ended.
14. **Set** – Marks the current location of the Play pointer and moves the Locate pointer to that position.

## Recording Setup

Recall, initiate, and manage recording sessions.

Press  
Record / Play

Touch  
New / Recall

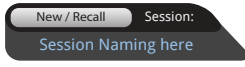

Refer to – Figure 68

1. **New Session Button** – Displays a keyboard used to enter a name and initiate a new session.
2. **Current Session Label** – Displays the name of the currently active recording/playback session.



**NOTE:** All session names must be in upper-case letters. The session you want to rename must be the current session.

3. **Rename Button** – Touch the Rename button to change the name of the current session.
4. **USB Sessions List** – Displays a list of recording sessions available on the USB device connected to the mixer. Select a session to Recall or Rename
5. **Record Pick-off Point Switch**

- *Pre* – Recorded signal is taken before the channel EQ, compressor and gate.
- *Post* – Recorded signal is taken after channel EQ, compressor and gate.

6. **Recall Session Button** – Loads the session selected in the USB Sessions window.



**NOTE:** To return to the main Record / Play screen, press the Home button.

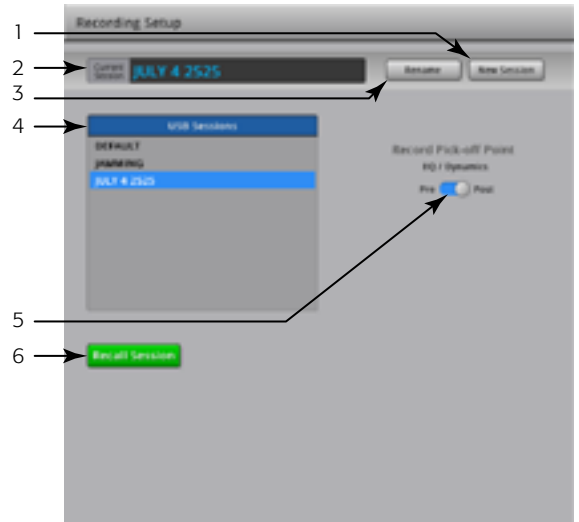

– Figure 68 –

## 2-Channel – Playback and Record

The Main L/R, Aux 7/8, or 9/10 can be recorded then played back over the Main L/R Outputs.

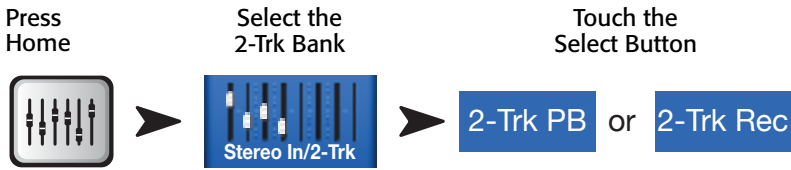

### 2-Track Recording Setup

Refer to – Figure 69

1. **Source Select Buttons** – Select the source for 2-Track recording. Main L/R, Aux 7/8 or Aux 9/10. (TouchMix-8 only Main L/R)
2. **Record Pick-off Point Switch** – Determines if the recorded audio is affected by the channel EQ and Dynamics (Post), or is not affected by the channel EQ and Dynamics (Pre).
3. **Arm to record Button** – When engaged, the source channels you selected are recorded when recording begins. This button is also available on the Record/Play screen.

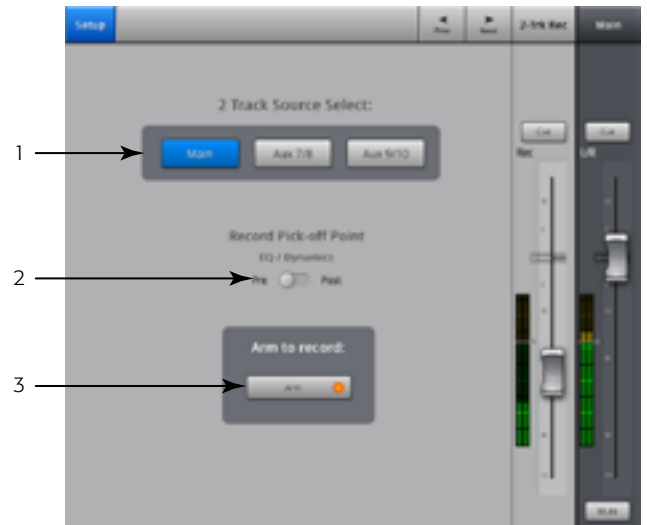

– Figure 69 –

### 2-Track Playback EQ

Refer to – Figure 70

1. **EQ Graph** – A graphic representation of the EQ settings.
2. **Low Cut Button** – Engages / disengages the filter. This filter cuts frequencies below the frequency set by the Freq control.
3. **High and Low Shelf Filter (1, 2) Buttons** – Engages / disengages the associated Shelf Filter.
4. **Gain Knob** – Adjusts the gain of the associated shelf filter over a range of -15 dB to +15 dB.
5. **Frequency Knob** – Sets the center, or shelving, frequency of the associated EQ band.
6. **Reset Button** – Sets all the EQ controls to their factory default position.
7. **EQ In Button** – Engages the equalizer.

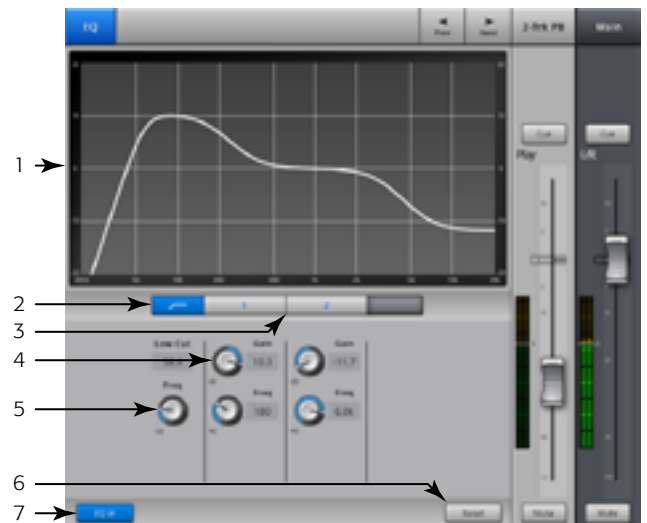

– Figure 70 –

# Wizard

## FX Wizard

The FX Wizard aids in adding FX to channels and routing those FX to monitors so your mixes have depth and sound fantastic!

Press Wizard

Touch FX Wizard



Refer to – Figure 71

1. **FX 1, 2, 3, 4 Buttons** – Selects which of the four FX mixes you want to work with.



**NOTE:** The Source, Type, and FX Preset windows provide a means of selecting an Effect based on what the source is.

If any of the lists fill the window, flick up on the list to show more selections.

2. **Source List** – Use the Source window to select the source instrument category.
3. **Type List** – Use the Type windows to select the type of instrument you want to send to the Effect processor.

At this point you have narrowed your selection enough for TouchMix to provide a list of recommended Effect presets.

4. **FX Preset List** – Use the FX Preset window to select the Effect and variation.

For example, in the FX Preset window if you see the letter “D”, it refers to the Dense Reverb Effect, and the text following the letter indicates the Preset (variation) of the Dense Reverb.

5. **Recall Button** – Loads the effect that has been selected in the Source, Type and FX Style windows.
6. **Clear Button** – Un-assigns all the inputs and outputs.
7. **Select Inputs to feed** FX 1 Mono 250 Delay **Label** – Each input channel is represented by a button. Touch one or more of these buttons to feed the input channel to the selected Effect.
8. **Cue Button** – Touch Cue above the FX fader to hear the output of the selected effect.
9. **Select Aux Output Buttons** – Each Aux Output is represented by a button. Touch one or more of these buttons to send the effect output to the associated Aux Output.

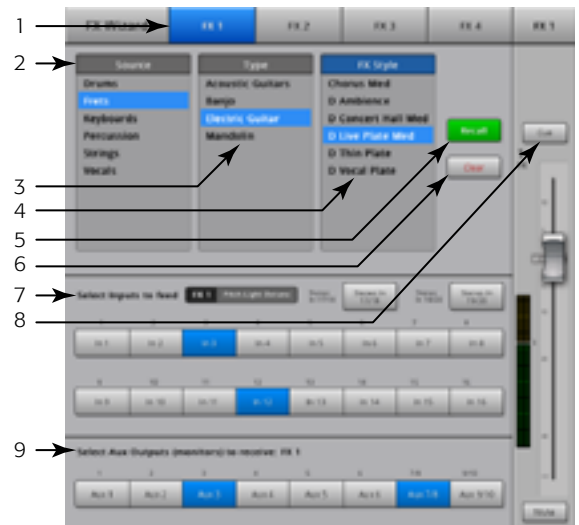

– Figure 71 –

## Gain Wizard

The Gain Wizard aids in adjusting analog input gains to avoid clipping and distortion so your mixes sound great!

Press Wizard

Touch Gain Wizard



Refer to – Figure 72



**NOTE:** The Gain Wizard is designed to assist *after* setting the Input Trim knobs, and during a performance. If a clip indication displays on the Nav Strip, use the Gain Wizard to determine how much you need to reduce the Trim. This is especially helpful when the clip was caused by a momentary spike.

1. **Reset Button** – Clears the Tick-Mark counters.
2. **Tick-Mark Counters** – Tells you how many tick marks to turn the Trim knob counterclockwise to prevent clipping. The number changes based on how long the input was clipping.
3. **Trim Knob** – Turn this knob (on the TouchMix surface) the number of tick marks indicated on the Tick-Mark counter.

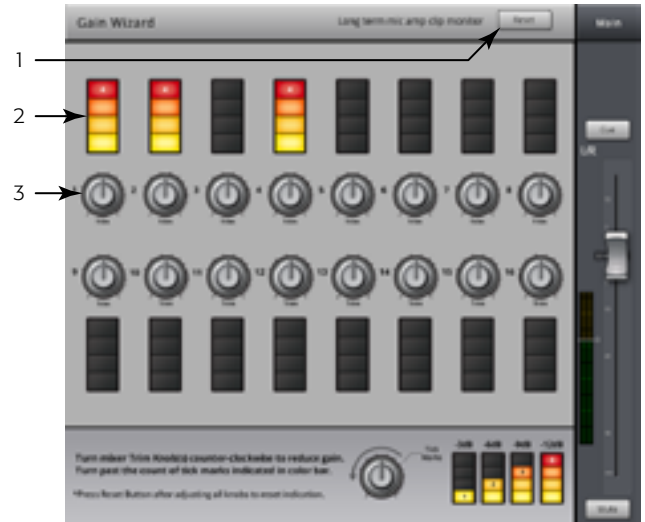

– Figure 72 –

## Aux Mix-on-Faders

Presents a single Aux Mix with large Sends faders.

Touch Aux

Select an Input Bank



Refer to – Figure 73



**NOTE:** **Cue** and **Mute** are not available on a remote device when its security is set to “Personal Monitor Mix”.

1. **Input and FX Bank Selectors** – The Nav Strip functions as it does for the Main L/R mix. Touch a block of mini-faders to navigate to a group of inputs or effects.
2. **Channel Select and Friendly Name** – touch a channel selector to go to the details for that channel.
3. **Mix Select Button** – Touch this button to select a different Aux mix.
4. **System Channel Name Labels** – 1 Mic, 2 Mic, ... does not change.
5. **Cue Buttons** – Sends signal from the channel input (AFL or PFL) to the Phones and Monitor (TouchMix-16, only) outputs.
6. **Send Faders** – Adjusts the level of the selected input channel in the Aux Mix.
7. **Channel Input Meter** – Displays the pre-fader / post-compressor & gate audio level of the channel.
8. **Aux Master Fader** – Adjusts the overall level of the Aux Mix.
9. **Mute Buttons** – Silences the channel output.



– Figure 73 –

# Dimensions

## TouchMix-8

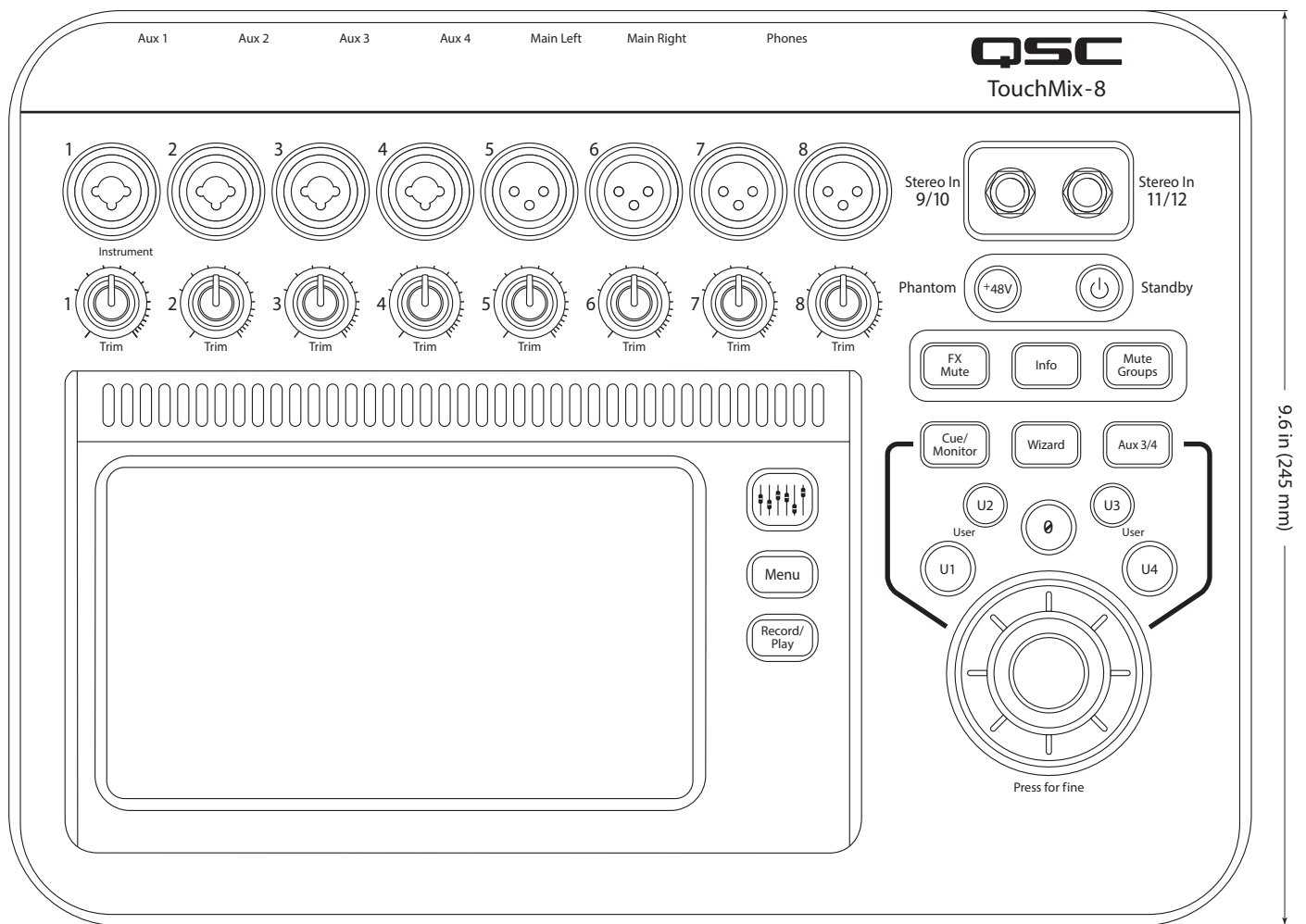
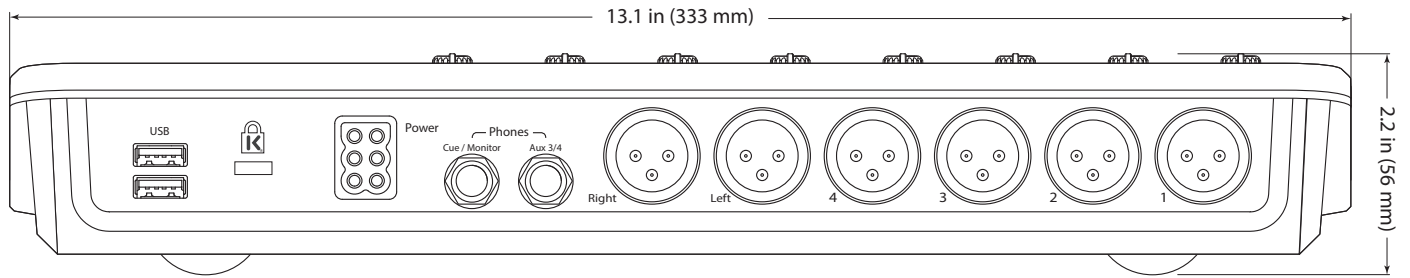

# TouchMix-16

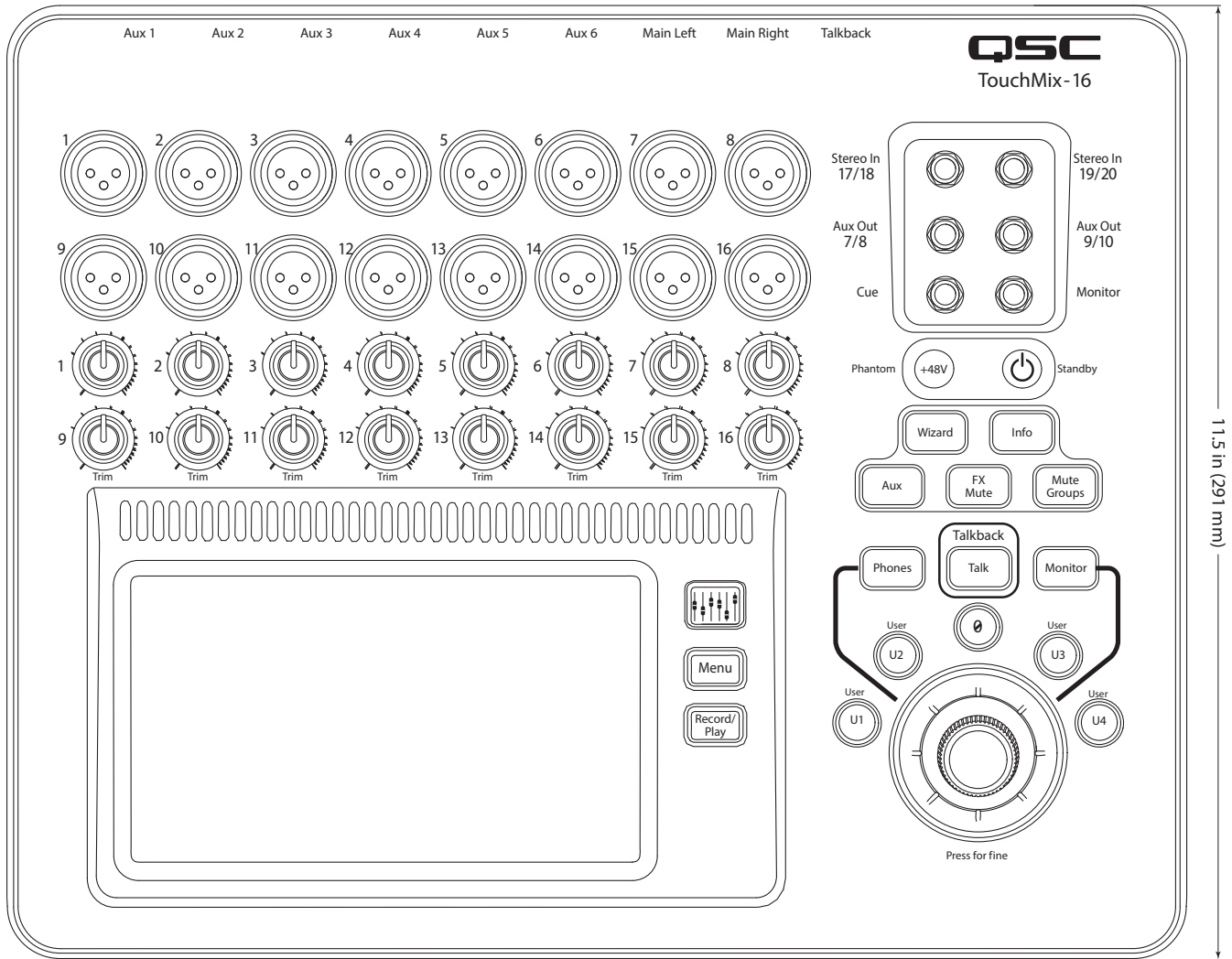
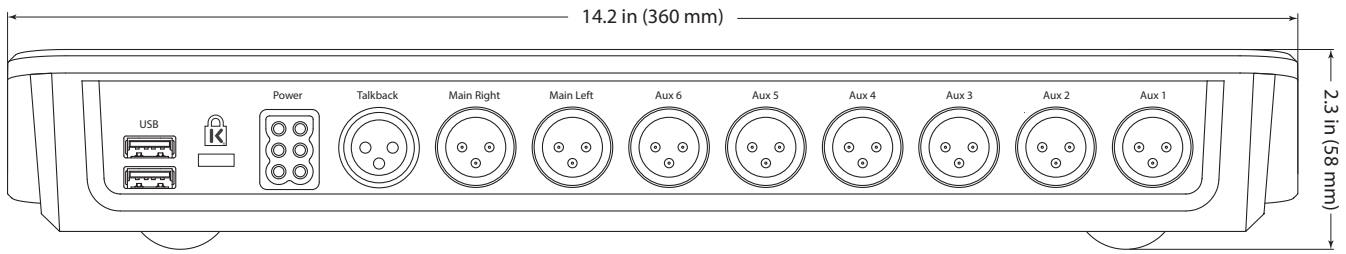

# Specifications

	<b>TouchMix-8</b>	<b>TouchMix-16</b>
Display (both models)	6.1" x 3.5" (156mm x 90mm) color TFT, touch sensing.	
Inputs (Mic/Line)	12 Total: 4, XLR/TRS combo 4, XLR 2 Stereo, 1/4" TRS	20 Total: 4, XLR/TRS combo 12, XLR 2 Stereo, 1/4" TRS
Input (Talkback)	N/A	1, XLR
Outputs	2 Main, XLR, line-level 4 Auxes, XLR, line-level 1 Stereo TRS, (Line or In-Ear Monitor, 16 ohm min. impedance) 1 Stereo Cue, TRS, (Line or headphone, 16 ohm min. impedance)	2 Main XLR, line-level 6 Auxes: XLR, line-level 2 Stereo auxes: TRS, (Line or In-Ear Monitor, 16 ohm min. impedance) 1 Stereo Monitor, TRS, (Line or headphone, 16 ohm min. impedance) 1 Stereo Cue, TRS, (Line or headphone, 16 ohm min. impedance)
Mic & Line Input Channel Processing	4-band parametric EQ with Hi/Low shelving option • variable 24db/octave Low-cut & High-cut filters • Gate • Compressor	
2-Track (USB) & FX Return Processing	2-band shelving EQ • variable 24db/octave Low-cut • Gate • Compressor	
Output Channel Processing	Main outputs and auxes 1–6: 1/3 octave graphic EQ • Limiter • 4 full-frequency notch filters • Variable 18dB/oct Low-cut and High-cut filters Auxes 7/8 & 9/10 (TM-16 only): 4-band parametric EQ, Limiter • Additional variable 18dB/oct Low-cut and High-cut filters	
Recording <sup>1</sup>	14 tracks, requires USB 3.0 HD • FAT32 format • minimum 7200 RPM	22 tracks, requires USB 3.0 HD • FAT32 format • minimum 7200 RPM
Groups	8 DCA groups (with mutes) • 8 Mute groups	
Cue	Selectable AFL or PFL	
Effects	4 professional effects engines configurable as reverb (2 types) • pitch shift • mono delay • stereo delay • chorus. 1 Pitch Correct (assignable to any mono input channel)	
Scene and Preset Memory	Scenes: 100 user-defined scenes, including all mixer parameters may be stored internally or on FAT32 formatted USB Channel and FX Presets: 100 user-defined channel presets and 100 FX presets may be stored internally or on FAT32 formatted USB	
External Control <sup>2</sup>	iOS TouchMix App for iPad, iPad mini, iPad Air, iPhone, and iPad Touch. Control via Wi-Fi provides access to all mixer functions. When run on iPhone and iPod touch, controls personal monitor mix, record/playback transport and user buttons. Requires iOS 7 or higher.	
Wi-Fi <sup>3</sup>	USB Wi-Fi adapter included	
Dimensions (HWD)	56 mm x 333 mm x 245 mm 2.2" x 13.1" x 9.6"	58 mm x 360 mm x 291 mm 2.3" x 14.2" x 11.5"
Weight	4.3 lb (1.95 kg)	5.9 lb (2.98 kg)
Line Voltage Requirements	100 - 240 VAC, 50 - 60 Hz	
Sampling Frequency	Selectable 44.1kHz or 48kHz	
Internal Processing	32-bit floating point	
Latency	<1.6msec, any input to any output	
THD	<0.005%, +4 dBu, 20 Hz - 20 kHz, unity gain, any input to any output	
Frequency Response	20 Hz - 20 kHz +/-0.5 dB, any input to any output	
Dynamic Range	105 dB	
Equivalent Input Noise	-126 dBu	
Residual Output Noise	-86 dBu	
Crosstalk	-80 dB	
S/N Ratio	-94 dB	
Maximum Input Level	+16 dBu (Mic/Line inputs, XLR), +26 dBu (Mic/Line inputs, TRS), +22 dBu (Stereo inputs)	
Phantom Power	48V, individually switchable per channel	
K & Lock® Security Slot <sup>4</sup>	Compatible with the MicroSaver Security Cable	
Included Accessories	USB WiFi adapter, Soft Carrying Case, Power Supply	

<sup>1</sup> A list of drives that have been validated by QSC may be found at [qsc.com](http://qsc.com). The hard-drive market is huge and continuously changing so there are many drives QSC has not validated that will work. Always test a new drive before using it for a critical session. Minimum requirement is USB 3.0 HD, SSD or 7200 RPM, FAT32 format.

<sup>2</sup> The TouchMix App requires iOS 7 or higher.

<sup>3</sup> Use only the Wi-Fi adapter supplied with your mixer.

<sup>4</sup> Available on early production models of TouchMix-16.



# TouchMix Block Diagram



© 2015 QSC Audio, Ltd  
Revised 3/30/2015

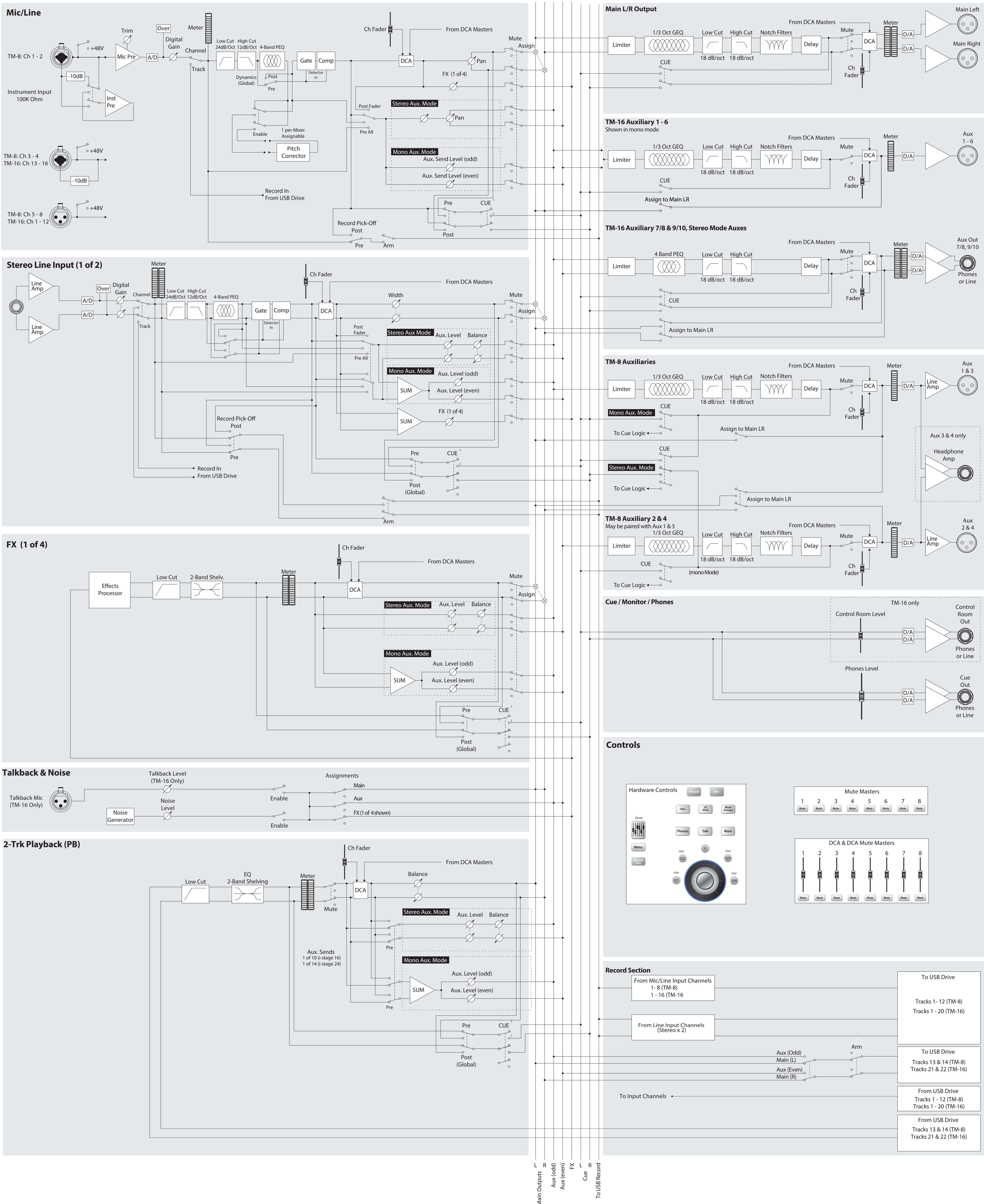



Mailing Address:

QSC Audio Products, LLC  
1675 MacArthur Boulevard  
Costa Mesa, CA 92626-1468 USA

Telephone Numbers:

Main Number: (714) 754-6175  
Sales & Marketing: (714) 957-7100 or toll free (USA only) (800) 854-4079  
Customer Service: (714) 957-7150 or toll free (USA only) (800) 772-2834

Facsimile Numbers:

Sales & Marketing FAX: (714) 754-6174  
Customer Service FAX: (714) 754-6173

World Wide Web:

[www.qsc.com](http://www.qsc.com)

E-mail:

[info@qsc.com](mailto:info@qsc.com)  
[service@qsc.com](mailto:service@qsc.com)

# TouchMix 2.1 User Guide Addendum

In addition to the features detailed in the 2.0 User Guide, firmware version 2.1 adds new functionality.

## Multi-Language Info System

Starting with software version 2.1, the mixer's built-in Info system is available in English (default), Chinese Mandarin, French, German, Spanish and Russian.

**To change the Info System language selection:** Menu > Language > Make a selection

The language for the mixer's built-in demo will also reflect the selected language option.

## Omit Outputs When Recalling a Scene

"Omit Outputs" allows a scene to be recalled without changing any of the mixer's output settings. Only the input channel parameters will be recalled. This function is useful when the operator wishes to recall a mix scene without changing carefully adjusted output levels, equalization and limiting for the Main L/R and Auxiliary outputs.

**To omit outputs from a scene recall:** Menu > Scenes > Set switch to "Omit Outputs"

Note that all mixer parameters including output settings will be saved as part of a scene. The 'Omit Outputs' function simply prevents recall of output channel parameters.

## Using Auxiliaries as Subgroups

The Auxiliary mixes may be assigned to the Main L/R output allowing the auxiliaries to function as subgroups. This feature is intended for use with the input channel "Assign To Main L/R" function.

**To use an Auxiliary as a Subgroup:**

- Home > Aux Outputs > Select an Aux > Setup > Select "Assign to Main L/R"
- Next go to the input channels > Setup > Deselect "Assign to Main L/R"
- Adjust the input channels' aux sends as desired.

## Support for MIDI-over-USB Footswitches

Numerous mixer functions including mutes, preset / scene recall, recording transport control and more can be controlled remotely by means of MIDI-over-USB devices. This function is similar in operation to the Programmable User Buttons and includes a "Learn MIDI" function that makes it easy to teach the mixer what MIDI command it should recognize and respond to.

**To control the mixer from a MIDI-over-USB device:**

- Attach a "class compliant" MIDI device to one of the USB ports.
- Push Menu > MIDI Setup > Select one of the MIDI buttons.
- Using the three windows, select an Action, a Selection and a Detail.
- Touch "Learn MIDI" and "Waiting for incoming MIDI message..." appears.
- On your MIDI device, push the switch that you want to associate with the action.

- Touch the small keyboard icon to name the function you just programmed.